

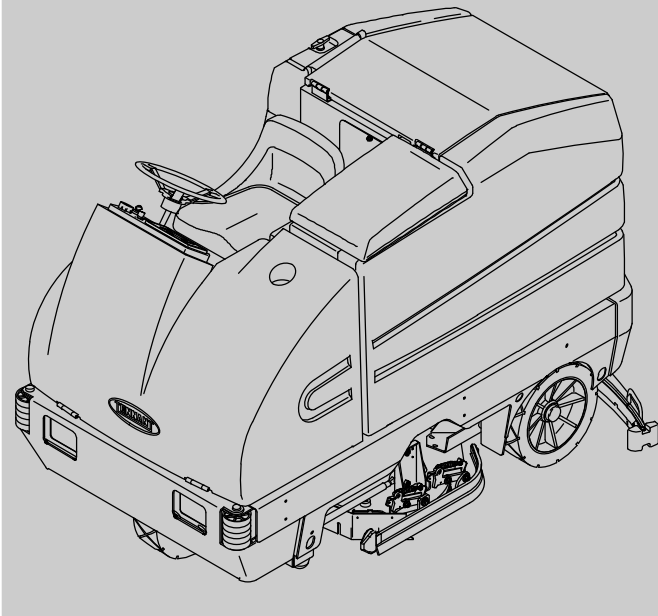

7300

(Battery)



Rider Scrubber Operator Manual



FaST
Foam Scrubbing Technology
The Safe Scrubbing Alternative®
ES® Extended Scrub System
TennantTrue® Parts
IRIS® a Tennant Technology



North America / International



For latest parts manual or other
Operator language manual, visit:

www.tennantco.com/manuals

330610
Rev. 19 (6-2014)



This manual is furnished with each new model. It provides necessary operation and maintenance instructions.



Read this manual completely and understand the machine before operating or servicing it.

This machine will provide excellent service. However, the best results will be obtained at minimum costs if:

- The machine is operated with reasonable care.
- The machine is maintained regularly - per the machine maintenance instructions provided.
- The machine is maintained with manufacturer supplied or equivalent parts.



PROTECT THE ENVIRONMENT

Please dispose of packaging materials, old machine components such as batteries, hazardous fluids such as antifreeze and oil, in an environmentally safe way according to local waste disposal regulations.



Always remember to recycle.

MACHINE DATA

Please fill out at time of installation for future reference.

Model No. – _____

Serial No. – _____

Machine Options – _____

Sales Rep. – _____

Sales Rep. phone no. – _____

Customer Number – _____

Installation Date – _____

Tennant Company

PO Box 1452

Minneapolis, MN 55440

Phone: (800) 553-8033 or (763) 513-2850

www.tennantco.com

Thermo-Sentry, SmartRelease, SuperScrub, and MaxPro are US registered and unregistered trademarks of Tennant Company.

Specifications and parts are subject to change without notice.

Copyright © 2000 – 2002, 2004 – 2014 TENNANT Company, Printed in U.S.A.

CONTENTS

	Page		Page
Safety Precautions	3	Pre-operation Checklist	36
Operation	5	Installing FaST PAK Agent	37
Operator Responsibility	5	Starting The Machine	39
Machine Components	6	Filling The Tanks	40
Symbol Definitions	7	Sweeping, Scrubbing And Brush	
Symbol Definitions	8	Information	43
Controls And Instruments	9	Scrubbing	45
Operation Of Controls	10	Double Scrubbing	50
Brake Pedal	10	Stop Scrubbing	50
Parking Brake Pedal	10	Draining And Cleaning The Tanks	51
Directional Pedal	10	Stop The Machine	56
Steering Wheel	11	Post-operation Checklist	57
On-off Key Switch	12	Operation On Inclines	58
Horn Button	12	Options	58
Power Kill Switch	13	Vacuum Wand	58
Operating Lights Switch	13	Power Wand	62
Power Wand Switch (Option)	13	Machine Troubleshooting	68
Solution Flow Lever	14	Maintenance	70
Steering Column Tilt Lever	14	Maintenance Chart	70
FaST Switch	14	Lubrication	72
ec-H2O Switch	15	Propelling Gearbox	72
Control Panel	15	Front Wheel Support Bearing	72
Changing Display Language	16	Scrub Head Drag Link Arms	
Battery Discharge Indicator	17	(S/N 000000-003695)	73
Hourmeter	17	Rear Wheel Bearings	74
Display Clock	18	Steering Gear Chain	74
Setting The Display Clock	18	Hydraulics (Option)	75
Scrub Switch	19	Hydraulic Fluid Reservoir	75
Super Scrub Switch (For machines		Hydraulic Fluid	76
without Optional Side Brush)	20	Hydraulic Hoses	76
Super Scrub Switch (For machines		Batteries	77
with Optional Side Brush)	20	Charging The Batteries	78
Recovery Tank Full Indicator	21	Control Panel	80
ES Switch (Option)	21	Electric Motors	82
Edge Scrub Switch	21	Propelling Circuit	82
Rear Squeegee Switch	22	Scrub Head	83
Side Brush Switch (Option)	23	Scrub Head Gas Spring	83
Detergent Pump Switch (Option)	24	Scrub Head Adjustments	83
Maintenance Mode	24	Scrub Brushes	84
Resetting The Maintenance Timers	25	Disk Brushes	84
Disabling The Maintenance Mode	26	Replacing The Disk Brushes	84
Fuses	27	Cylindrical Brushes	87
Circuit Breakers	28	Checking And Adjusting Cylindrical	
Solution Tank Drain Hose (Option)	30	Brush Pattern	87
Recovery Tank Drain Hose	30	Replacing The Cylindrical Brushes	90
Positive Solution Control Drain		Side Sweeping Brush (Option)	92
(Option)	30	Replacing And Adjusting The Side	
Latches	30	Sweeping Brush(Es)	92
Operator Seat	31	Solution System	93
Deluxe Suspension Seat (Option)	31	Solution Valve	93
Side Brush Adjustment Knob (Option)	32	Recovery Tank	93
How The Machine Works	33	Solution Tank	94
FaST Scrubbing System	34		
ec-H2O System (Option)	35		

CONTENTS

	Page		Page
FaST System	95	Specifications	116
FaST Supply Hose Connector	95	General Machine Dimensions/Capacities	116
FaST System Filter Screen	95	Fast System	116
FaST System Air Pump Filter (S/N 000000–003746)	95	General Machine Performance	116
FaST System Air Pump Filter (S/N 003747–)	96	Power Type	117
ec–H2O Module Flush Procedure	97	Steering	118
Squeegees	99	Hydraulic System	118
Rear Squeegee	99	Braking System	118
Leveling The Rear Squeegee	99	Tires	118
Adjusting Rear Squeegee Blade Deflection	100	ec–H2O System	118
Removing The Rear Squeegee Assembly	101	Machine Dimensions	119
Side Squeegee	102	Index	120
Adjusting The Side Squeegee	102		
Squeegee Blades	102		
Rear Squeegee Blades	102		
Replacing Or Rotating The Rear Squeegee Blades	102		
Side Squeegees Blades	104		
Replacing The Side Squeegee Blades	104		
Belts And Chains	105		
Brush Drive Belts	105		
Steering Gear Chain	105		
Static Drag Chain	105		
Skirts And Seals	106		
Scrub Head Floor Skirts	106		
Front Cover Seals	106		
Solution Tank Cover Seal	107		
Recovery Tank Cover Seal	107		
Brakes And Tires	108		
Brakes	108		
Tires	108		
Front Wheel	108		
Pushing, Towing, And Transporting The Machine	109		
Pushing Or Towing The Machine	109		
Transporting The Machine	109		
Machine Jacking	111		
Storage Information	112		
Freeze Protection (Machines Without Optional ec–H2O System)	112		
Freeze Protecting The ec–H2O System	113		
Flushing Antifreeze From The ec–H2O Module	115		

SAFETY PRECAUTIONS

The following symbols are used throughout this manual as indicated in their description:



WARNING: To warn of hazards or unsafe practices that could result in severe personal injury or death.

FOR SAFETY: To identify actions that must be followed for safe operation of equipment.

The following information signals potentially dangerous conditions to the operator or equipment. Read this manual carefully. Know when these conditions can exist. Locate all safety devices on the machine. Then, take necessary steps to train machine operating personnel. Report machine damage or faulty operation immediately. Do not use the machine if it is not in proper operating condition.



WARNING: Batteries emit hydrogen gas. Explosion or fire can result. Keep sparks and open flame away. Keep covers open when charging.



WARNING: Flammable materials can cause an explosion or fire. Do not use flammable materials in tank(s).



WARNING: Flammable materials or reactive metals can cause explosion or fire. Do not pick up.

FOR SAFETY:

This machine may be equipped with technology that automatically communicates over the cellular network. If this machine will be operated where cell phone use is restricted because of concerns related to equipment interference, please contact a Tennant representative for information on how to disable the cellular communication functionality.

1. Do not operate machine:

- Unless trained and authorized.
- Unless operation manual is read and understood.
- Unless mentally and physically capable of following machine instructions.
- In flammable or explosive areas unless designed for use in those areas.
- In areas with possible falling objects unless equipped with overhead guard.

2. Before starting machine:

- Make sure all safety devices are in place and operate properly.
- Check brakes and steering for proper operation.

3. When starting machine:

- Keep foot on brake and directional pedal in neutral.

4. When using machine:

- Use brakes to stop machine.
- Go slow on inclines and slippery surfaces.
- Use care when backing machine.
- Do not carry riders on machine.
- Follow mixing and handling instructions on chemical containers.
- Always follow safety and traffic rules.
- Report machine damage or faulty operation immediately.
- Follow safety guidelines concerning wet floors.

5. Before leaving or servicing machine:

- Stop on level surface.
- Set parking brake.
- Turn off machine and remove key.

6. When servicing machine:

- Avoid moving parts. Do not wear loose jackets, shirts, or sleeves when working on machine.
- Block machine tires before jacking machine up.
- Jack machine up at designated locations only. Block machine up with jack stands.
- Use hoist or jack that will support the weight of the machine.
- Wear eye and ear protection when using pressurized air or water.
- Disconnect battery connections before working on machine.
- Wear protective gloves and eye protection when handling vinegar.
- Avoid contact with battery acid.
- Use Tennant supplied or equivalent replacement parts.

SAFETY PRECAUTIONS

- 7. When loading/unloading machine onto/off truck or trailer:**
 - **Turn off machine.**
 - **Use truck or trailer that will support the weight of the machine.**
 - **Use winch. Do not drive the machine onto/off the truck or trailer unless the load height is 380 mm (15 in) or less from the ground.**
 - **Set parking brake after machine is loaded.**
 - **Block machine tires.**
 - **Tie machine down to truck or trailer.**

The safety labels appear on the machine in the locations indicated. If these or any label becomes damaged or illegible, install a new label in its place.

FLAMMABLE MATERIALS LABEL – LOCATED ON THE INSIDE OF THE SOLUTION TANK COVER.

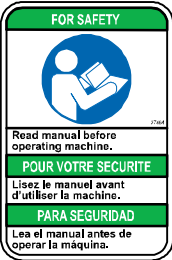
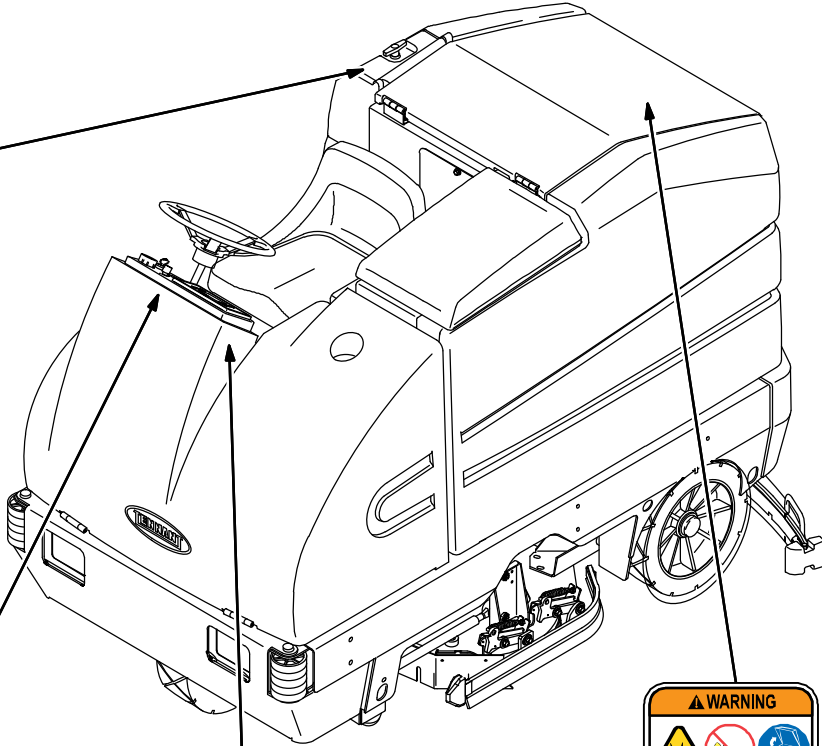

FOR SAFETY LABEL – LOCATED ON THE INSIDE OF THE OPERATOR COMPARTMENT.



FLAMMABLE SPILLS LABEL – LOCATED ON THE INSIDE OF THE OPERATOR COMPARTMENT.



BATTERY CHARGING LABEL – LOCATED ON THE LINTEL.

OPERATOR RESPONSIBILITY

- The operator's responsibility is to take care of the daily maintenance and checkups of the machine to keep it in good working condition. The operator must inform the service mechanic or supervisor when the maintenance intervals are required as stated in the *MAINTENANCE* section of this manual.

- Read this manual carefully before operating this machine.

FOR SAFETY: Do not operate machine, unless operation manual is read and understood.

- Check the machine for shipping damage. Check to make sure the machine is complete per shipping instructions.
- Keep your machine regularly maintained by following the maintenance information in this manual. We recommend taking advantage of a regularly scheduled service contract from your Tennant representative.
- Order parts and supplies directly from your authorized Tennant representative. Use the parts manual provided when ordering parts.
- After the first 50 hours of operation, follow the recommended procedures stated in the *MAINTENANCE CHART*.

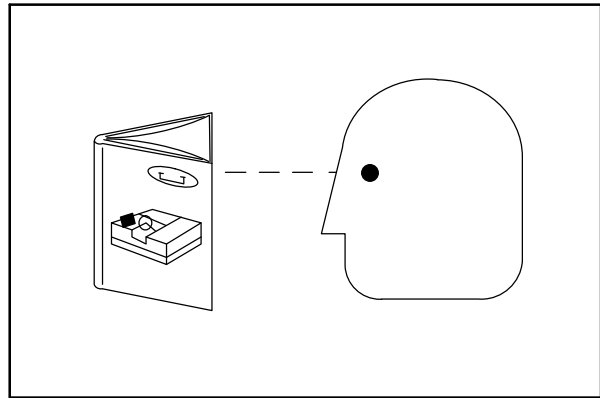

07324

MACHINE COMPONENTS

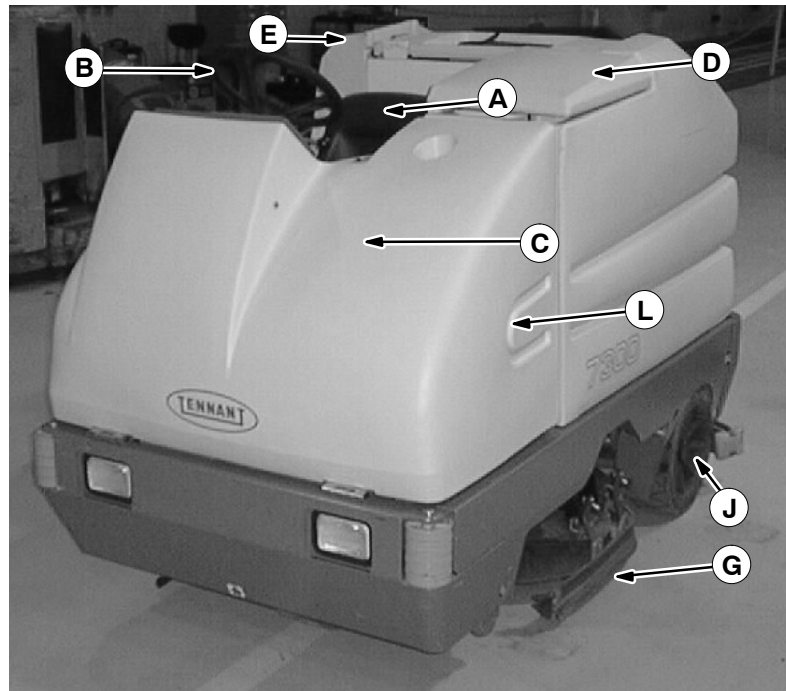
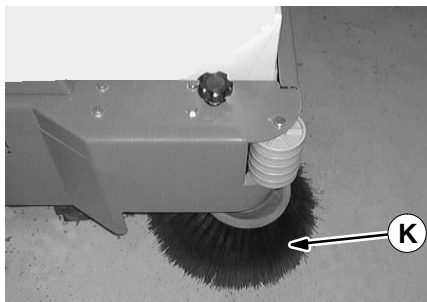
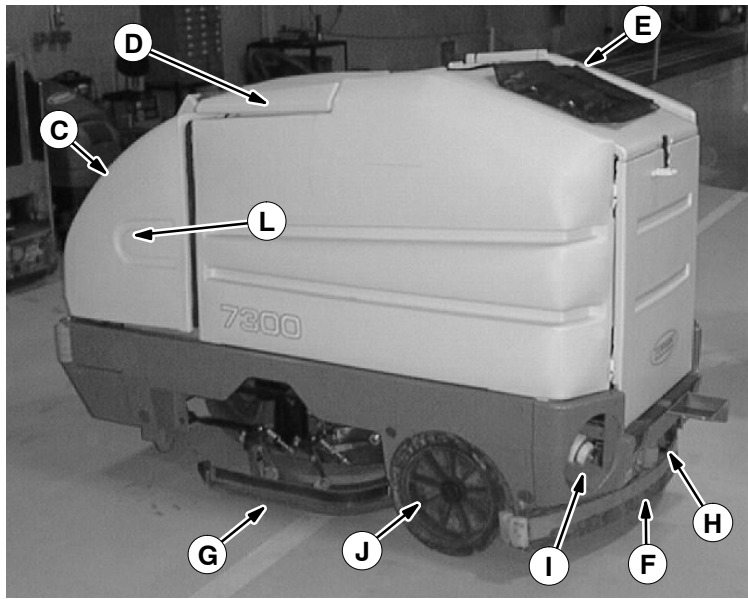

- A. Operator seat
- B. Steering wheel
- C. Machine cover
- D. Recovery tank
- E. Solution tank
- F. Rear squeegee
- G. Side squeegee
- H. Solution tank drain
- I. Recovery tank drain
- J. Rear wheel
- K. Side Brush (Option)
- L. FaST solution system
ec-H2O System Module (Option)

OPERATION

SYMBOL DEFINITIONS

These symbols identify controls, displays, and features on the machine:



Battery charging system



Hourmeter



Recovery tank full



ES (option)



Scrub switch



Scrub brush up and off



Scrub brush down pressure



Super scrub



Scrub brush edge clean



Squeegee up



Squeegee down



Key switch



Operating lights



Hazard light (option)



Solution tank full



Solution tank low



Variable pressure



Steering tilt



Circuit breaker #1



Circuit breaker #2



Circuit breaker #3



Circuit breaker #4



Circuit breaker #5



Circuit breaker #6



Circuit breaker #7



Circuit breaker #8



Circuit breaker #9



Circuit breaker #10

SYMBOL DEFINITIONS



Horn



50 hour required maintenance interval



100 hour required maintenance interval



500 hour required maintenance interval



1000 hour required maintenance interval



Detergent flow on (option)



Detergent flow heavy (option)



Detergent flow off (option)



Side brush down and on (option)



Side Brush up and off (option)



ec-H2O (option)



Circuit breaker #11



Circuit breaker #12



Circuit breaker #13



Circuit breaker #14



Circuit breaker #15



Circuit breaker #16



Circuit breaker #17



Circuit breaker #18



Diagnostics



Power Wand (option)



Jackpoint

CONTROLS AND INSTRUMENTS

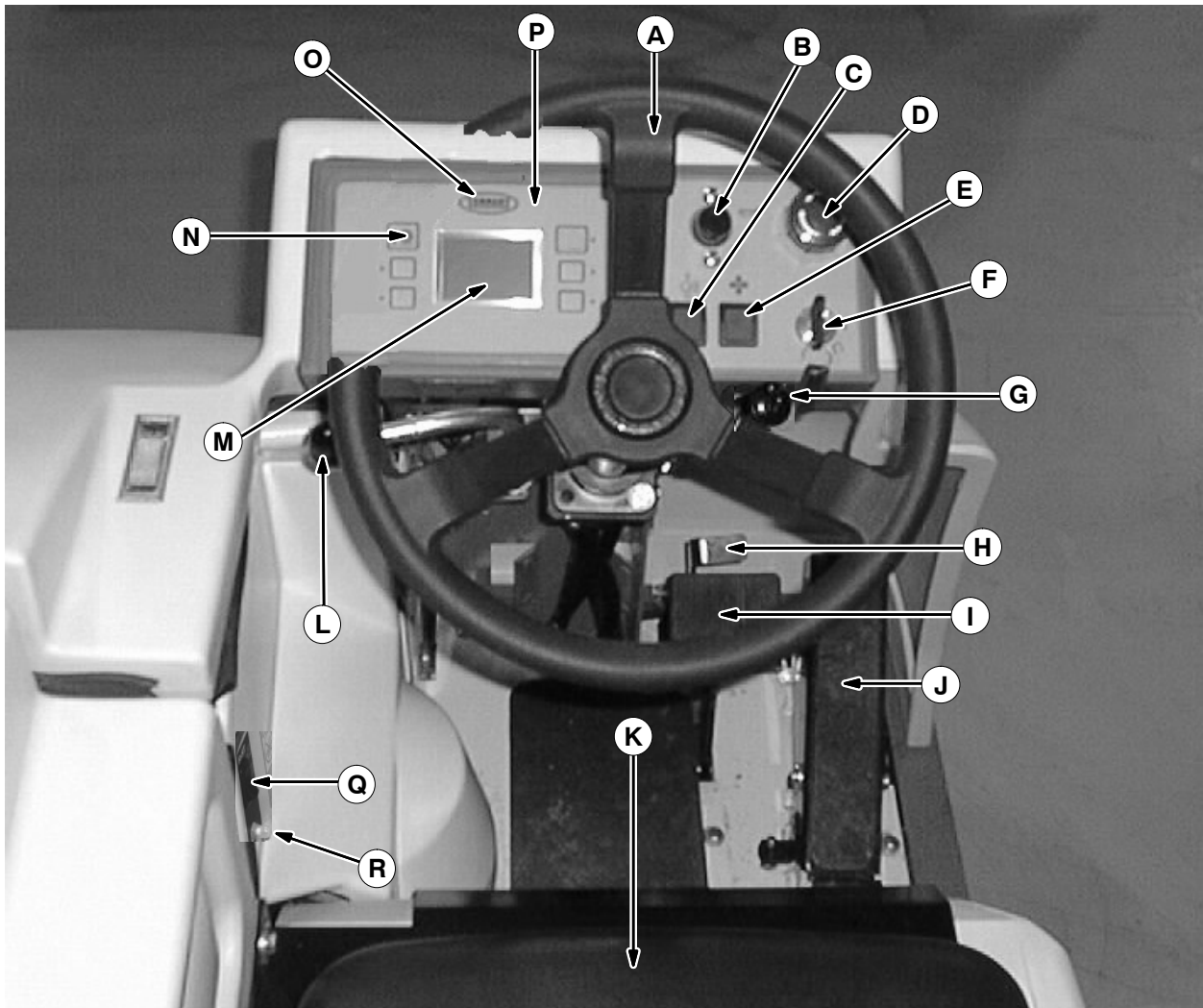

- A. Steering wheel
- B. Horn button
- C. Operating lights switch
- D. Power kill switch
- E. Power wand switch (option)
- F. On/Off key switch
- G. Steering column tilt lever
- H. Parking brake pedal
- I. Brake pedal
- J. Directional pedal
- K. Operator seat
- L. Solution flow lever
- M. Display screen
- N. Multi-function switches (6)
- O. TENNANT logo switch
- P. Control panel
- Q. FaST switch
- ec-H2O system on/off switch (option)
- R. ec-H2O system indicator light (option)

OPERATION OF CONTROLS

BRAKE PEDAL

The brake pedal stops the machine.

Stop: Take your foot off the directional pedal and let it return to the neutral position. Step on the brake pedal.

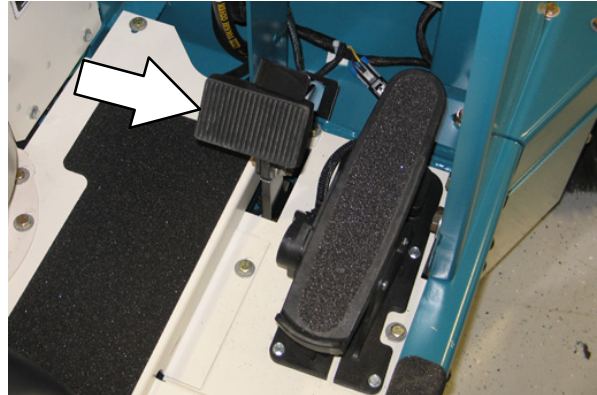
**PARKING BRAKE PEDAL**

The parking brake pedal sets and releases both of the rear wheel brakes.

Set: Press the brake pedal down as far as possible, then press on the parking brake pedal with the toe of your foot to lock the parking brake pedal in place.

FOR SAFETY: Before leaving or servicing machine, stop on level surface, set parking brake, turn off machine, and remove key.

Release: Press down on the brake pedal until the parking brake releases.

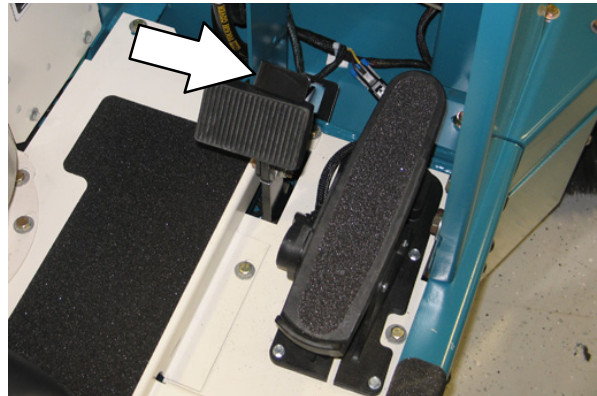
**DIRECTIONAL PEDAL**

The directional pedal controls direction of travel and the propelling speed of the machine. You change the speed of the machine with the pressure of your foot; the harder you press the faster the machine travels.

When the machine is moving forward and the directional pedal is reversed, the machine will coast for a short distance before changing direction. Use the brake pedal to stop the machine.

Forward: Press the top of the directional pedal with the toe of your foot.

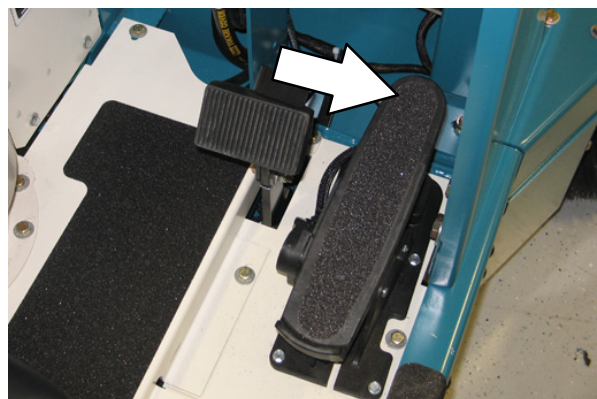

OPERATION

Reverse: Press the bottom of the directional pedal with the heel of your foot.

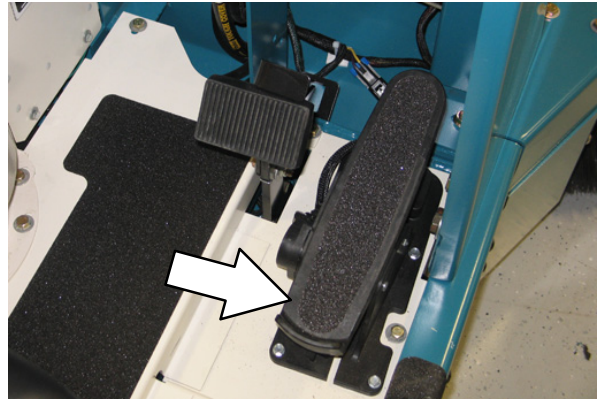

Neutral: Take your foot off the directional pedal and it will return to the neutral position.

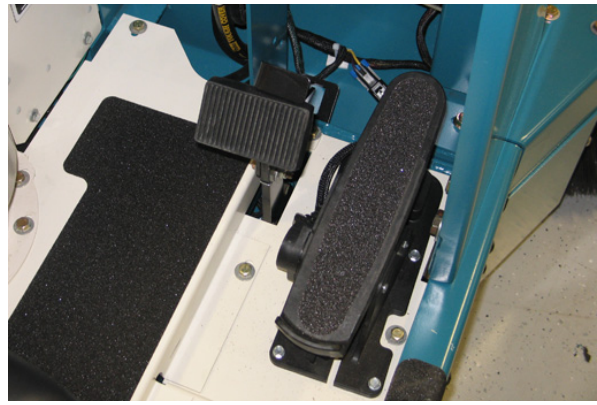

STEERING WHEEL

The steering wheel controls the machine's direction. The machine is very responsive to the steering wheel movements.

Left: Turn the steering wheel to the left.

Right: Turn the steering wheel to the right.

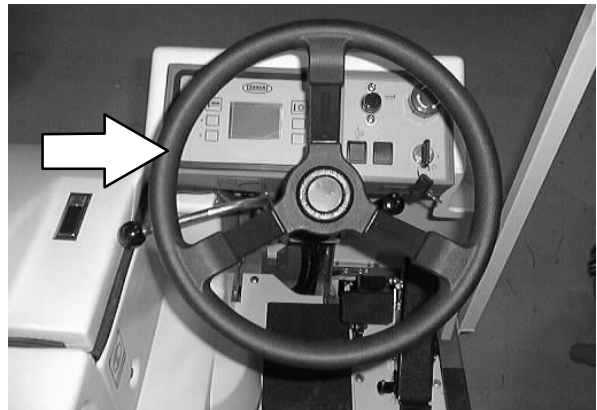

ON-OFF KEY SWITCH

The on-off key switch controls machine power with a key.

FOR SAFETY: When starting machine, keep foot on brake and directional pedal in neutral.

On: Turn the key clockwise all the way.

Off: Turn the key counter-clockwise.

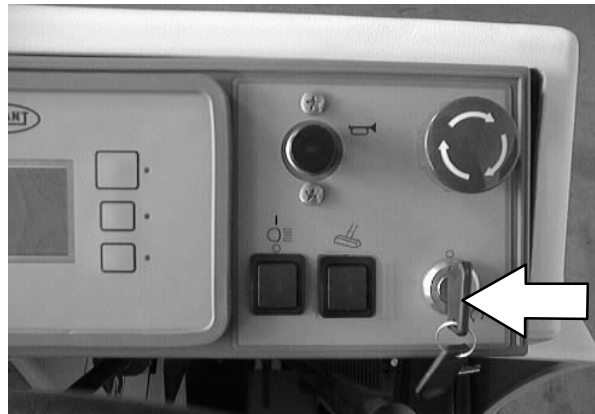
**HORN BUTTON**

The horn button operates the horn.

Sound: Press the button.

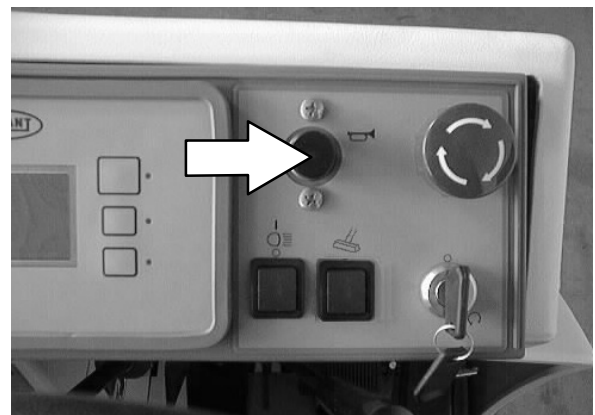

OPERATION

POWER KILL SWITCH

The power kill switch halts all power to the machine.

FOR SAFETY: When starting machine, keep foot on brake and directional pedal in neutral.

Halt: Push the power kill switch in.

Restart: Turn off the machine with the on/off switch. Turn the power kill switch to the right to release the switch. Turn on the machine with the on/off key switch.

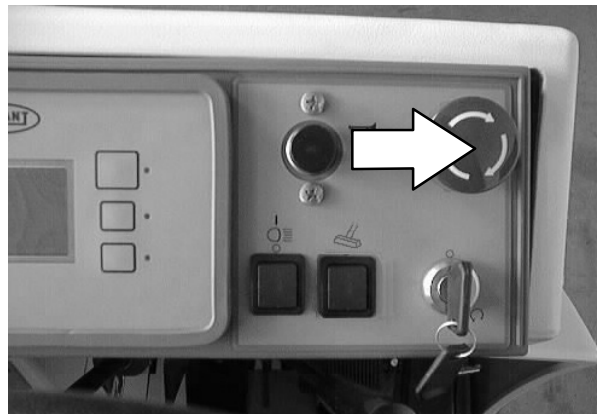

OPERATING LIGHTS SWITCH

The operating lights switch powers on and off the headlights and taillights.

On: Press the top of the operating lights switch.

Off: Press the bottom of the operating lights switch.

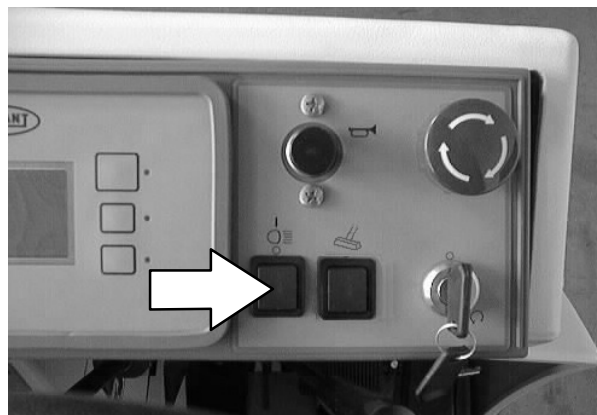

POWER WAND SWITCH (OPTION)

The power wand switch turns on and off the power wand solution system option.

On: Press the top of the switch.

Off: Press the bottom of the switch.

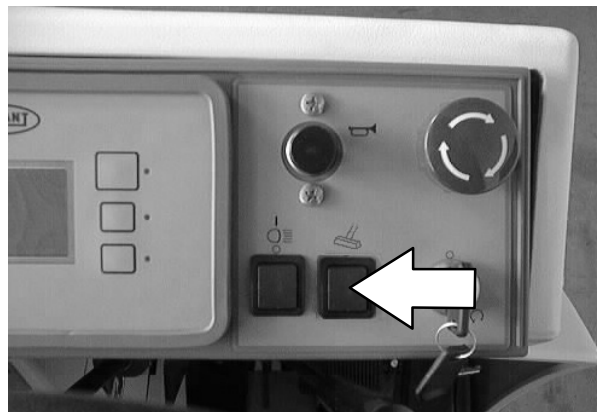

SOLUTION FLOW LEVER

The solution flow lever controls the amount of solution flow to the floor.

Increase flow: Raise the lever.

Decrease flow: Lower the lever.

Stop flow: Lower the lever all the way down.

NOTE: When using the FaST or ec-H2O system (option), the solution flow lever is nonfunctional. The FaST and ec-H2O system flow rates are pre-set. The ec-H2O module has optional flow rate settings. If solution flow adjustments are required, contact an Authorized Service Center.



STEERING COLUMN TILT LEVER

The steering column tilt lever is used to adjust the angle of the steering column. To tilt the steering column, pull the lever slightly down toward the operator seat. Position the steering wheel at the desired position, then release the lever.

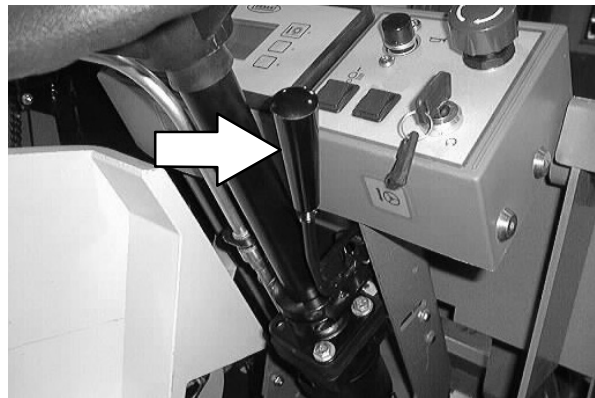

FaST SWITCH

The FaST switch enables the FaST (Foam Scrubbing Technology) system. When the FaST system is enabled, it is turned on and off with the scrub switch. Disable the FaST system before using the machine for conventional scrubbing.

Disable FaST for conventional scrubbing: Press the top of switch to the **FaST system off** position.

Enable the FaST system 1: Press the middle of switch to the **low FaST system** solution flow position.

Enable the FaST system 2: Press the bottom of the switch to the **high FaST system** solution flow position.

NOTE: The FaST system will not start until the directional pedal is pressed.

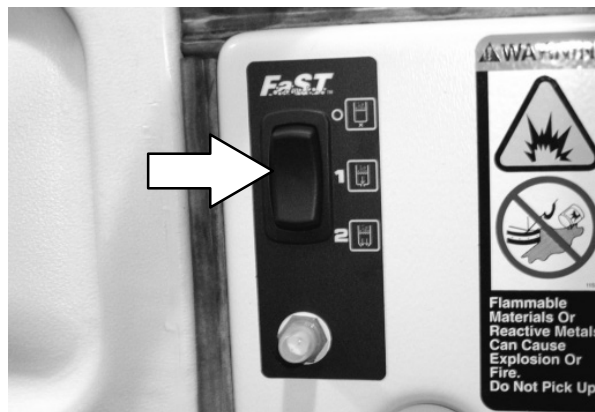

OPERATION

ec-H2O SWITCH (OPTION)

The ec-H2O switch (option) enables the ec-H2O (Electrically activated water) system. When the ec-H2O system is enabled, it is turned on and off with the scrub switch.

ec-H2O low setting: Press the top of the ec-H2O switch.

ec-H2O high setting: Place the ec-H2O switch into the middle position.

Conventional scrubbing: Press the bottom of the ec-H2O switch.

NOTE: The ec-H2O system will not start until the machine starts scrubbing.

NOTE: Do not enable the ec-H2O system with conventional cleaning detergents in the solution tank. Drain, raise and refill the solution tank with clear cool water only before operating the ec-H2O system. Conventional cleaning detergents/restorers may cause failure to the ec-H2O solution system.



CONTROL PANEL

The scrubbing and optional sweeping functions are activated by the control panel. Features of the control panel include six multi-function buttons and graphics icons which display the current state of the scrubbing and optional sweeping functions. The control panel also features a display clock for operator convenience, and a maintenance mode that prompts the operator when to perform routine machine maintenance.

By pressing the TENNANT logo switch, the operator can cycle the control panel display through the different function screens. Each function screen allows the operator to enable or disable different scrubbing functions.

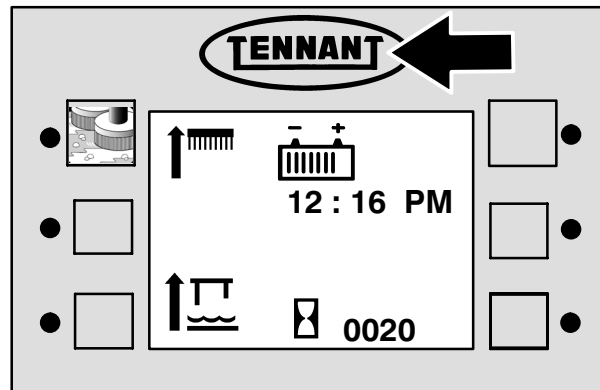

352550

CHANGING DISPLAY LANGUAGE

1. Turn the machine power off.
2. Press and hold the logo switch.

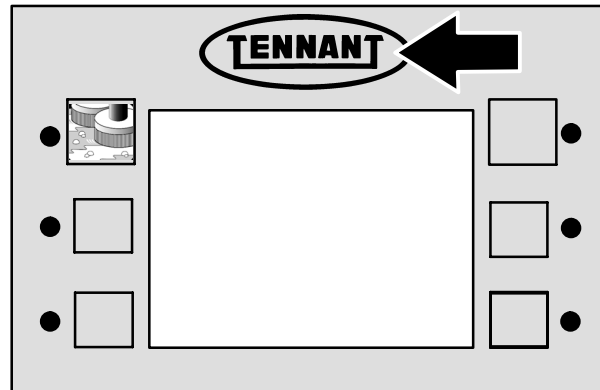

353556

3. Turn the machine power on.
4. Continue pressing the logo switch for 15 seconds or until the down pressure display screen appears.
5. Press and release the logo switch 3 times to scroll to the language select mode.

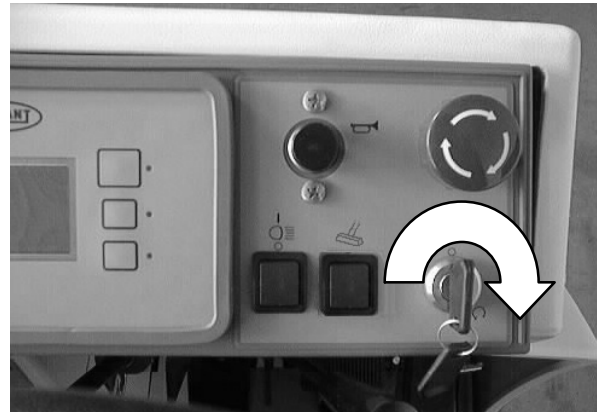

6. Press the first switch on the control panel to scroll through the list of languages until the desired language is displayed.
7. Turn the machine power off, and the new language will be stored in the control panel.

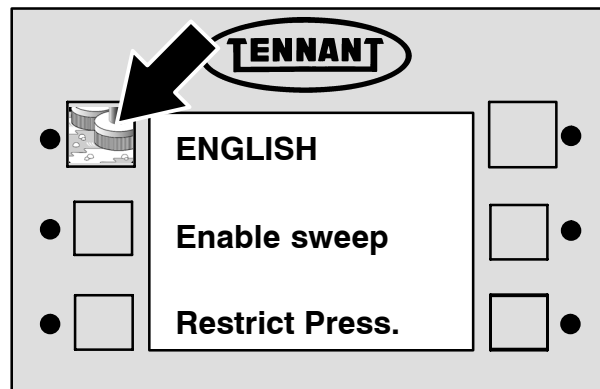

353555

OPERATION

BATTERY DISCHARGE INDICATOR

The battery discharge indicator shows the charge level of the batteries with a segmented display.

When the batteries are fully charged, all the segments are lit. As the batteries discharge, the segments shut off.

The batteries should be recharged when all the segments have shut off. At this point, the battery icon will begin flashing, and the scrubbing functions will automatically shut off to alert the operator of the battery condition. The squeegee and vacuum can be operated, with the rear squeegee switch, for an additional 30 seconds to pick up any excess water.

NOTE: Do not charge the batteries more often than is necessary to prolong the life of the batteries. Do not charge the batteries with a "top off" charge if there is enough remaining charge in the batteries for the next machine use. Discharge the batteries to a 20% level, when the battery discharge indicator segments shut off, before fully charging the batteries. Do not allow the batteries to become completely discharged as this will also damage the batteries. See BATTERIES in the MAINTENANCE section.

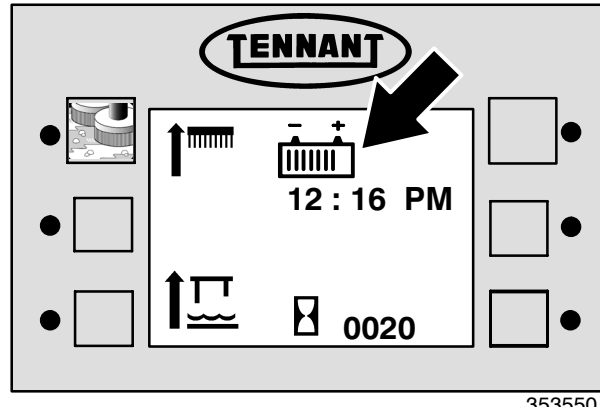

353550

HOURMETER

The hourmeter records the number of hours the machine has been operating.

The hourmeter will record time when the machine is propelling or when the vacuum fan is operating. This information is useful when maintaining the machine.

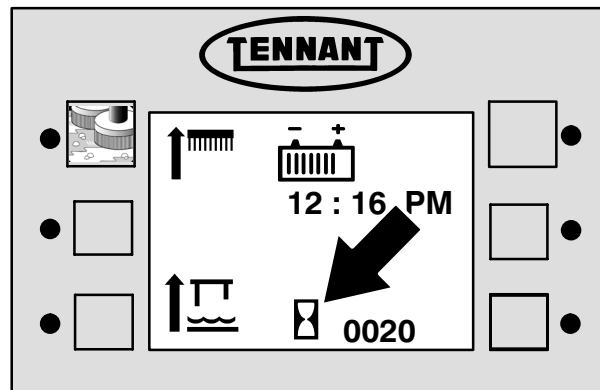

353550

DISPLAY CLOCK

The display clock shows the time of day below the battery discharge indicator.

SETTING THE DISPLAY CLOCK

1. Turn the machine off.
2. Press and hold the logo switch.
3. Turn the machine power on.
4. Continue pressing the logo switch for 15 seconds or until the down pressure display screen appears.
5. Press and release the logo switch one time to scroll to the adjust time mode.
6. Press the switch next to ADJUST TIME.

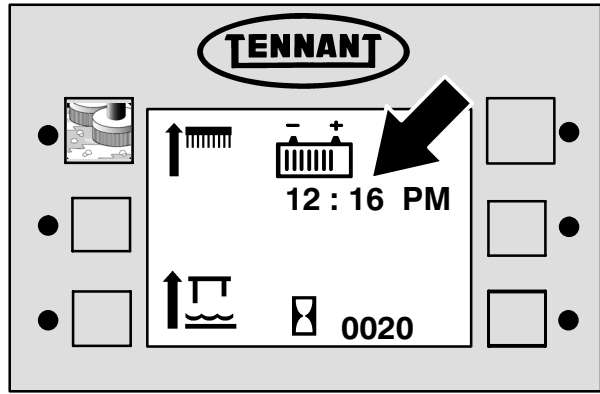

353550

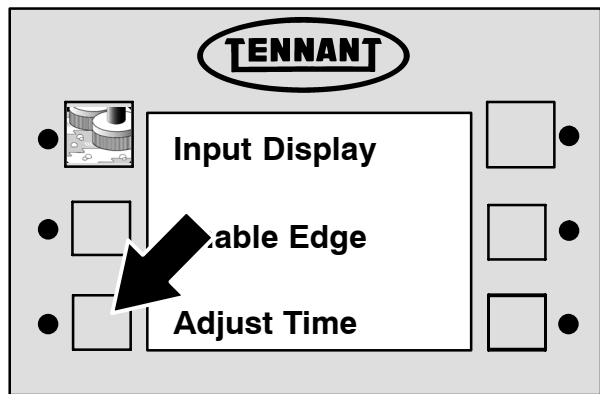

353553

7. Set the time, date, and choose between the 12 or 24 hour clock modes by moving the underline through the display by pressing the switches next to the direction arrows. Increase the value of the underlined segment by pressing the switch next to the positive (+) icon. Decrease the value of the underlined segment by pressing the switch next to the negative (-) icon.
8. Exit the ADJUST TIME function by pressing the TENNANT logo switch.
9. Turn the key to the off position.

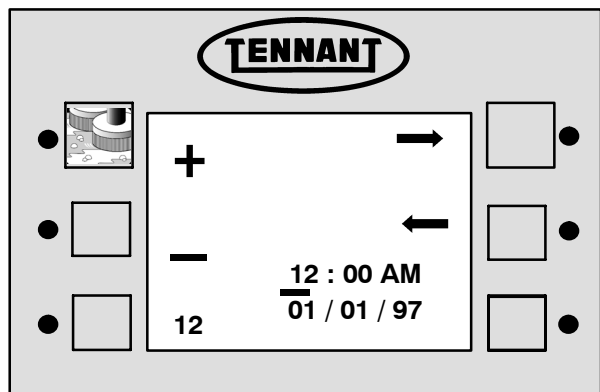

353557

OPERATION

SCRUB SWITCH

The scrub switch controls the scrubbing and optional sweeping operations. The scrub switch also sets the scrub brush pressure.

The scrubbing operations include the following: The scrub head lowers and the scrub brushes turn on. The rear squeegee will lower and the vacuum fan will start. The optional sweeping side brush(es) lowers and the sweeping brushes turn on. The solution system will start, if the solution flow lever is on. The optional FaST, *ec-H2O*, or ES system and detergent pump will start, if the switches are on.

Start scrubbing: Press the scrub switch. The indicator light next to the switch will illuminate. The scrubbing system will start when the machine moves forward.

NOTE: The brush pressure setting, the FaST / ec-H2O system, the detergent flow rate, the edge scrub, and the ES system will default to the last setting used when the scrubbing operations are started again.

Stop scrubbing: Press the scrub switch. The indicator light next to the switch will go off. First the scrub brushes will stop and raise, then the rear squeegee will raise and the vacuum will shut off.

Scrub brush pressure: Press and hold the scrub switch. The brush pressure will scroll through three settings indicated by the small arrows above the brush icon. Each arrow indicates a heavier brush pressure setting.

There is also a fourth brush pressure setting indicated by one large arrow above the brush icon and for machines without the optional side brush, a large arrow will appear in the upper right hand corner of the display screen. It is the heaviest brush pressure setting, and it is called Super Scrub. It is activated for 30 seconds by pressing the scrub switch twice quickly, or by pressing the Super Scrub switch once. See the SUPER SCRUB SWITCH section of the manual.

The pressure setting selected when the scrub switch is released will be the new default brush pressure setting.

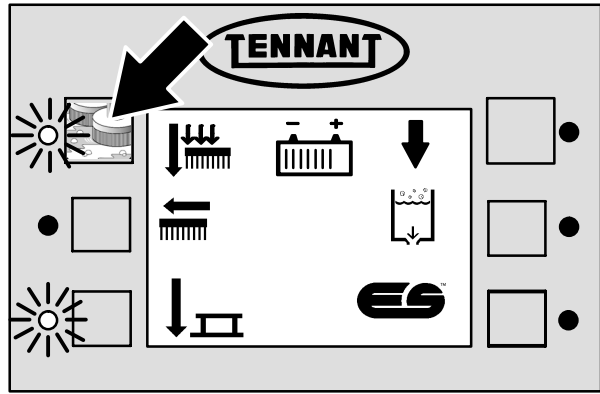

353562

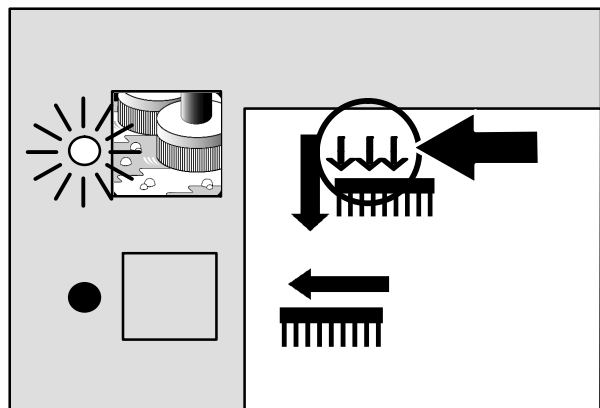

353567

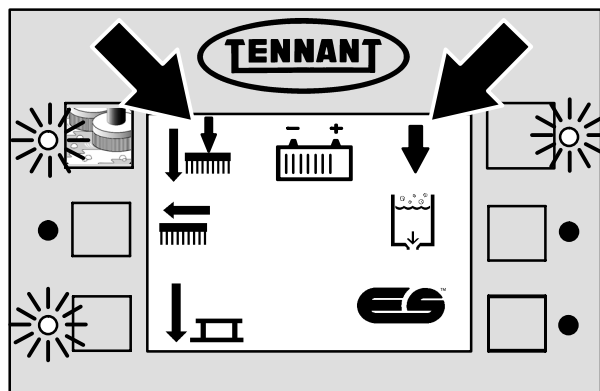

353563

Under normal conditions, the brush pressure should be set in the minimum settings (one or two downward arrows). Under heavy grime conditions, the brush pressure should be set in the maximum settings (three downward arrows or one large arrow). Travel speed and floor conditions will affect the scrubbing performance.

NOTE: The rear squeegee will raise and the vacuum will shut off when the machine travels in reverse. The squeegee will lower and the vacuum starts again when the machine travels forward.

NOTE: The scrub brushes will stop when the machine is stopped for a short time. The brushes will start again when the machine travels forward.

NOTE: The scrub switch also controls the FaST/ec-H₂O system (option) when the FaST/ec-H₂O system is enabled with the FaST/ec-H₂O switch.

**SUPER SCRUB SWITCH
(For machines without Optional Side Brush)**

The Super Scrub switch activates the heaviest or fourth scrub brush pressure setting for 30 seconds.

On: Press the switch. The indicator light next to the switch will illuminate.

Off: Press the switch. The indicator light next to the switch will go off. (Super Scrub will automatically shut off after 30 seconds)

NOTE: The Super Scrub icon only appears after the scrub functions have been activated.

NOTE: The Super Scrub can also be activated by pressing the scrub switch twice quickly.

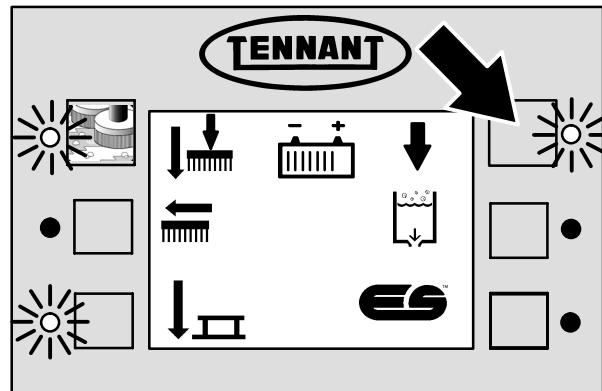

353562

**SUPER SCRUB SWITCH
(For machines with Optional Side Brush)**

The Scrub Brush switch activates the heaviest or fourth scrub brush pressure setting for 30 seconds.

On: Pressing the scrub switch twice quickly. One large arrow above the brush icon will appear.

Off: Press the switch (Super Scrub will automatically shut off after 30 seconds). The large arrow above the brush icon will disappear.

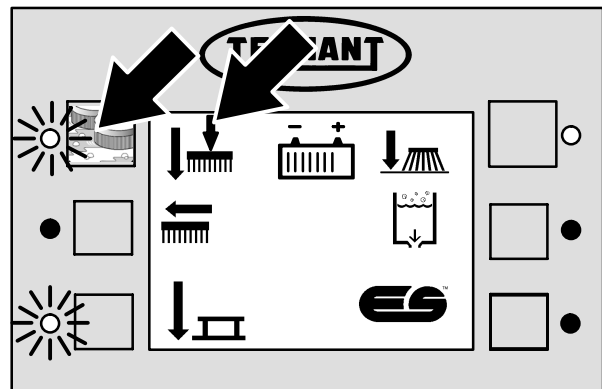

353562

OPERATION

RECOVERY TANK FULL INDICATOR

The recovery tank full indicator comes on when the recovery tank is full.

If the recovery tank full indicator stays on for more than 7 seconds, the “Rec. Tank Full” message will appear in the hourmeter display. The scrub brushes and vacuum will shut off, and the rear squeegee will raise.

To pick up excess water after the vacuum has shut off and the rear squeegee has raised, press and hold the rear squeegee switch.

NOTE: Do not overfill the recovery tank. Overfilling the recovery tank may damage the vacuum fans.

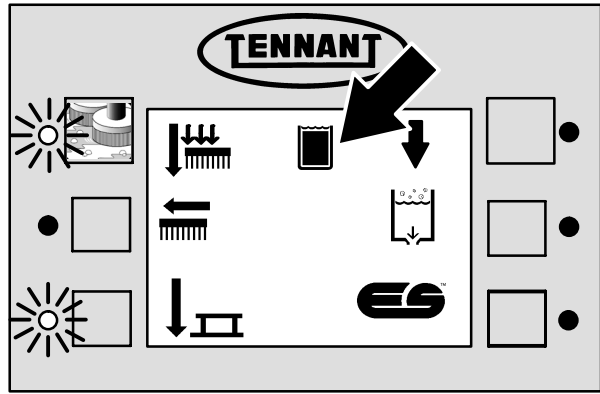

353563

ES SWITCH (OPTION)

The ES (Extended Scrub) switch turns on and off the solution recycling system. When the scrubbing functions have started, the ES will default to the last setting used.

On: Press the switch. The indicator light next to the switch will illuminate.

Off: Press the switch. The indicator light next to the switch will go off.

NOTE: The ES icon only appears after the scrub functions have been activated.

NOTE: When using the ES (option), the recovery tank 1/2 full float must be active for the pump to operate.

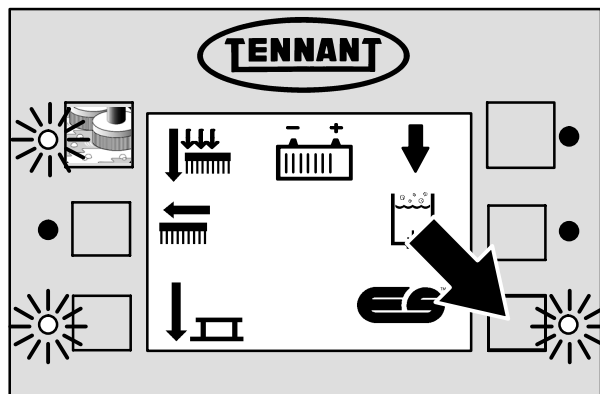

353563

EDGE SCRUB SWITCH

The edge scrub switch extends the scrub head to the right to allow close edge scrubbing. When the scrubbing functions have started, the edge scrub will default to the last setting used.

NOTE: The edge scrub icon only appears after the scrub functions have been activated.

On: Press the switch during normal scrubbing. The indicator light next to the switch will illuminate.

Off: Press the switch again. The indicator light next to the switch will go off.

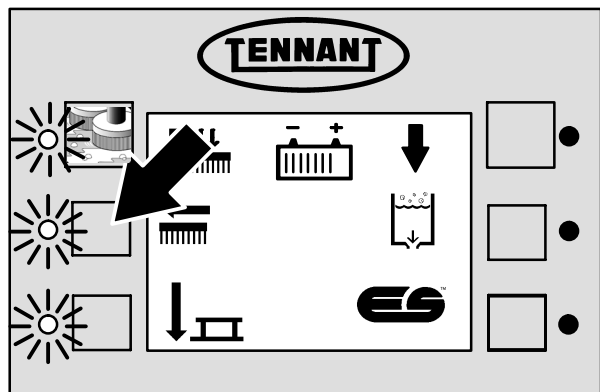

353563

REAR SQUEEGEE SWITCH

The rear squeegee switch controls the vacuum fan and the position of the rear squeegee. The rear squeegee can be operated separately from the scrub brushes for the purpose of picking-up excess water without scrubbing, or double scrubbing without water pick up

Lower squeegee and start the vacuum fan: Press the squeegee switch. The indicator light next to the switch will illuminate.

Raise squeegee and stop the vacuum fan: Press the squeegee switch. The indicator light next to the switch will go off. There will be a slight delay before the vacuum shuts off.

NOTE: The rear squeegee lowers and scrubbing vacuum starts automatically when the scrubbing operations start.

NOTE: The rear squeegee will raise and the scrubbing vacuum will shut off after a short delay when the machine travels in reverse.

NOTE: The rear squeegee will raise and the scrubbing vacuum fan will shut off after a short delay when the scrubbing operations are shut off.

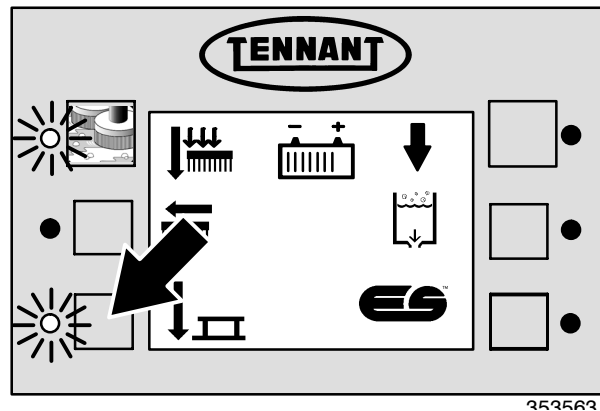

OPERATION

SIDE BRUSH SWITCH (OPTION)

The *side brush switch* controls the side brush position and rotation. The scrubbing brush must be operating for the side brush to work. This option is available only on cylindrical scrub head machines.

NOTE: The side brush operates automatically when the scrub brush starts operating. To scrub without using the side brush, press the side brush switch.

Down and On: Press the *side brush switch*. The indicator light next to the switch will illuminate, then the side brush will lower and activate.

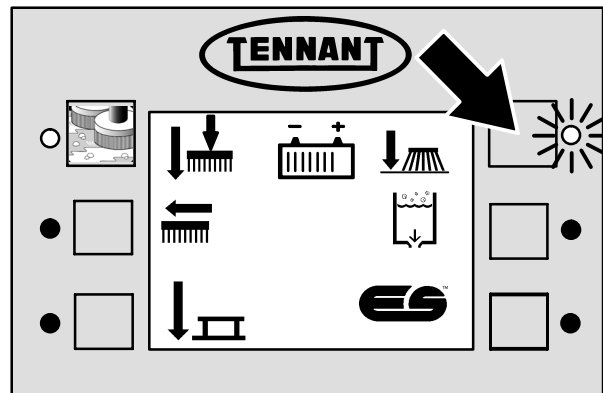

Up and Off: Press the *side brush switch*. The indicator light next to the switch will go out, then the side brush will stop and raise.

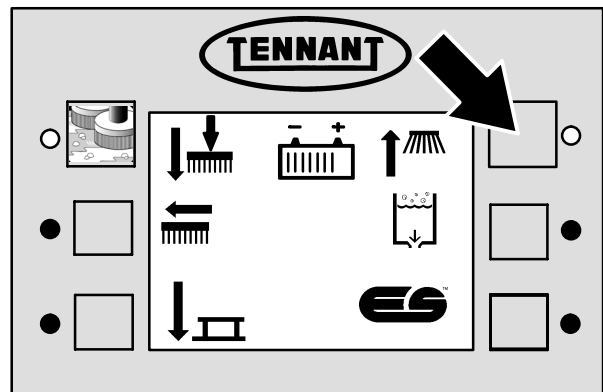

DETERGENT PUMP SWITCH (OPTION)

The detergent pump switch controls the amount of detergent that flows to the floor while scrubbing. When the scrubbing functions have started, the detergent pump switch will default to the last setting used.

NOTE: The detergent icon only appears after the scrub functions have been activated.

NOTE: The detergent pump switch will not activate unless the main scrub brushes are active and the solution flow lever is on.

High: Press and hold the detergent pump switch until two downward pointing arrows appear on the icon next to the switch. Release the switch. The indicator light next to the switch will illuminate.

Low: Press and hold the detergent pump switch until one downward pointing arrow appears on the icon next to the switch. Release the switch. The indicator light next to the switch will illuminate.

Off: Press and release the detergent pump switch. An 'X' will appear under the detergent pump icon. The indicator light next to the switch will go off.

NOTE: When using the ec-H₂O system (option), the detergent pump switch is nonfunctional.

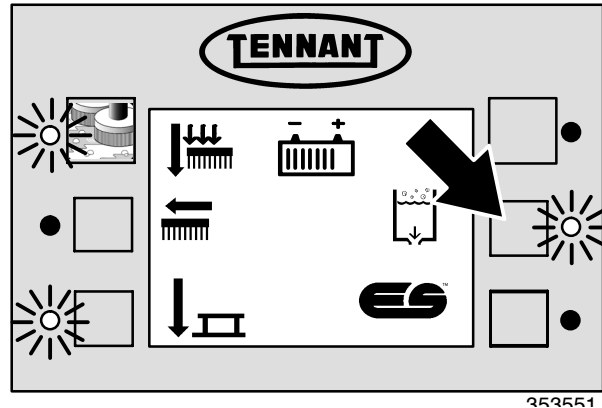

MAINTENANCE MODE

The maintenance mode allows the operator to monitor and reset the elapsed time between the four different regular maintenance requirements.

When the maintenance mode is enabled, an alarm will sound, and one of several service maintenance icons will appear on the display each time the machine is started. This will happen if one or more of the maintenance timers goes past its recommended interval. Each time the required maintenance function is performed, the timer for that function should be reset.

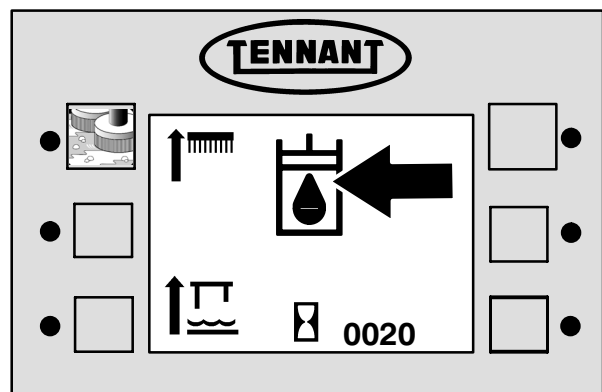

OPERATION

RESETTING THE MAINTENANCE TIMERS

1. Turn the machine off.
2. Press and hold the logo switch.
3. Turn the machine power on.
4. Continue pressing the logo switch for 15 seconds or until the down pressure display screen appears.
5. Press and release the logo switch two more times. The SELF TEST screen will appear on the display.

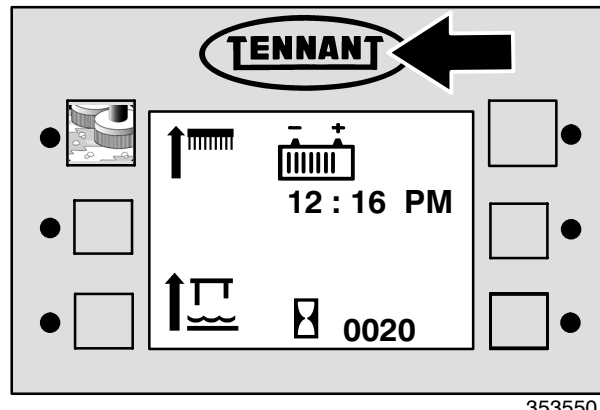

6. Press the switch next to DISPLAY MAINT.

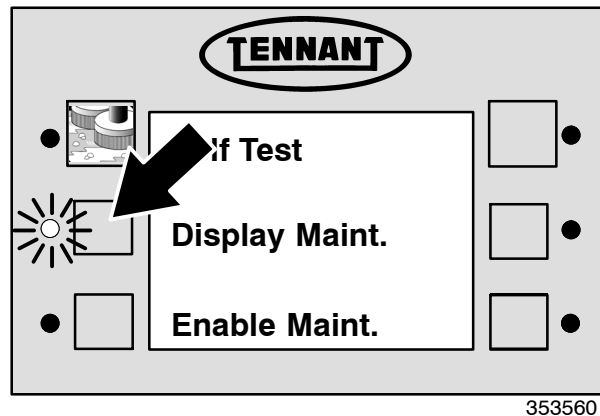

Each maintenance item is represented by an icon with the recommended maintenance interval printed in hours below it. The lower right-hand corner of the screen displays the number of hours that have elapsed since the maintenance timer was last reset and the date it was last reset. The switch at the upper right-hand corner of the screen will reset the hour counter for each maintenance item. Reset the maintenance timer each time the maintenance function represented by the icon is performed. The operator can scroll through the four maintenance function screens by pressing the logo switch.

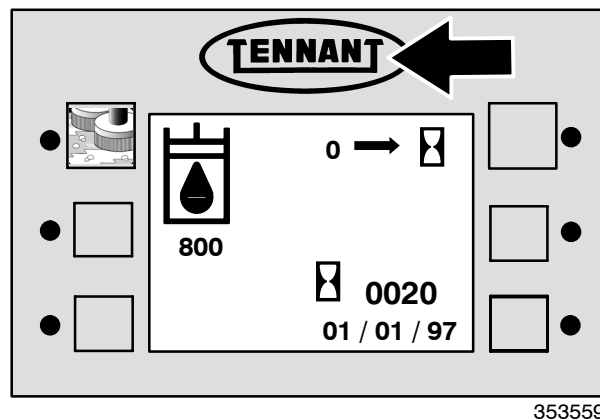

To determine which routine maintenance function each icon represents, see the *SYMBOL DEFINITIONS* section of this manual.

7. Exit the DISPLAY MAINT. function by pressing the logo switch until all four maintenance mode screens have been displayed.
8. Turn the key to the off position.

DISABLING THE MAINTENANCE MODE

When the maintenance mode is disabled, the flashing icon and alarm will not appear and sound when the machine is started if one or more of the maintenance timers goes past its recommended interval.

1. Turn the machine off.
2. Press and hold the logo switch.
3. Turn the machine power on.
4. Continue pressing the logo switch for 15 seconds or until the down pressure display screen appears.
5. Press and release the logo switch two more times. The SELF TEST screen will appear on the display.

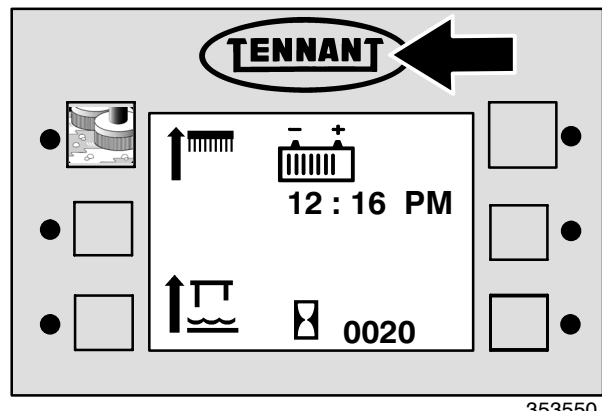

6. Press the switch next to ENABLE MAINT..

NOTE: If the light next to the ENABLE MAINT. switch is not illuminated, the maintenance mode is currently disabled.

NOTE: When the maintenance mode is disabled, the maintenance timers continue to record the elapsed time between maintenance intervals. To view the elapsed time between each of the six default maintenance intervals, press the switch next to Display Maint.. Press the logo switch to scroll through the maintenance function screens.

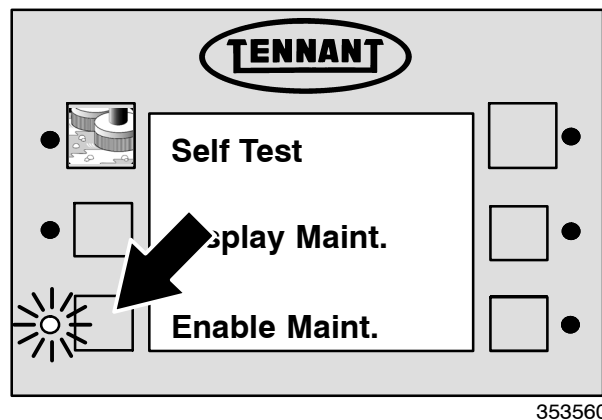

OPERATION

FUSES

The fuses are one-time circuit protection devices designed to stop the flow of current in the event of a circuit overload. Never substitute higher value fuses than those specified in this manual.

The main propelling fuse is located under the circuit breakers in the electrical panel. The two actuator fuses are located in the control panel.

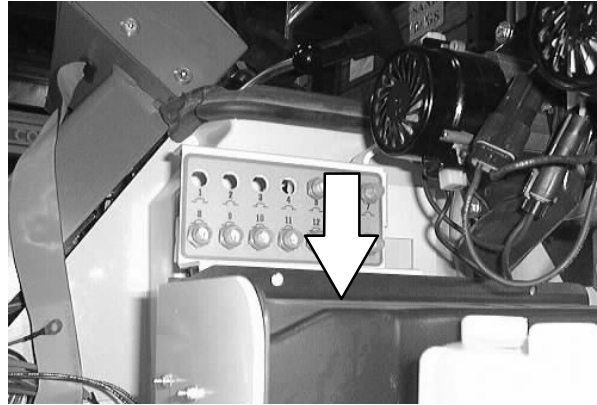

Fuse	Rating	Circuit Protected
FU 1	150 A	Propelling
FU 2	10 A	Electronic Actuator
FU 3	10 A	Electronic Actuator

CIRCUIT BREAKERS

The circuit breakers are resettable electrical circuit protection devices. They stop the flow of current in the event of a circuit overload. Once a circuit breaker is tripped, reset it manually by pressing/flipping the reset button after the breaker has cooled down.

If the overload that caused the circuit breaker to trip is still there, the circuit breaker will continue to stop current flow until the problem is corrected.

The circuit breakers are located to the left of the operator's compartment next to the vacuum fans.

The charts shows the circuit breakers and fuses, and the electrical components they protect.

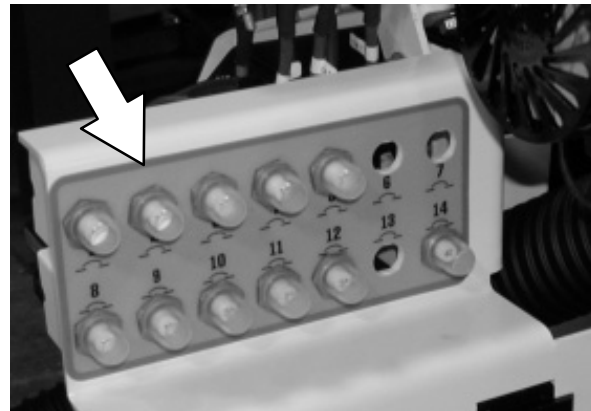
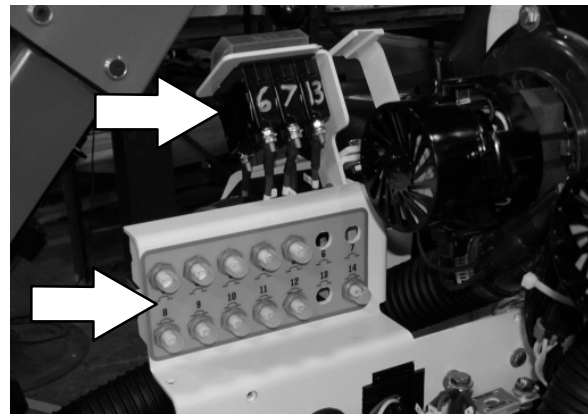

Circuit Breaker	Rating	Circuit Protected
CB1	-	Open
CB2	-	Open
CB3	-	Open
CB4	15 A	Power Wand/Sweeping Side Brush
CB5	2.5 A	Key Switch
CB6	50 A	Right Scrub Motor (000000-001705)
CB6		Open (001706-)
CB7	50 A	Left Scrub Motor (000000-001705)
CB7		Open (001706-)
CB8	15 A	Lights
CB9	2.5 A	Horn
CB10	20 A	Vac Fan #1 (000000-001705)
CB10	30 A	Vac Fan #1 (001706-)
CB11	20 A	Vac Fan #2 (000000-001705)
CB11	30 A	Vac Fan #2 (001706-)
CB12	25 A	Control Board
CB13	50 A	Center Scrub Motor (000000-001705)
CB13		Open (001706-)
CB14	40 A	Power Steering Pump
CB15	10 A	FaST

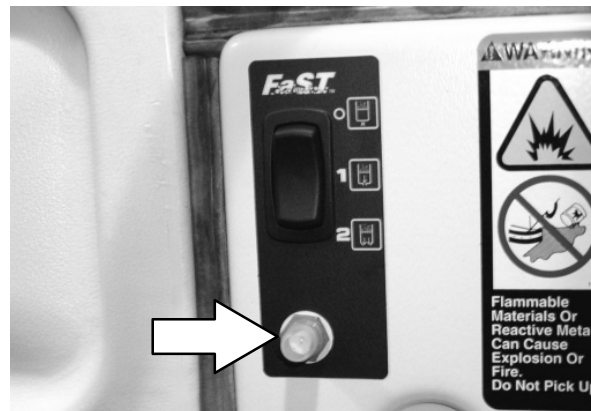

OPERATION

This chart shows the magnetic circuit breakers used on machines serial number 001706 and up for all **cylindrical scrub heads**.

Circuit Breaker	Rating	Circuit Protected
CB6	45	Right Scrub Motor
CB7	45	Left Scrub Motor
CB13	Open	

This chart shows the magnetic circuit breakers used on machines serial number 001706 and up with **Max Pro 1000 standard motor disk scrub heads**.

Circuit Breaker	Rating	Circuit Protected
CB6	40	Right Scrub Motor
CB7	40	Left Scrub Motor
CB13	Open	

This chart shows the magnetic circuit breakers used on machines serial number 001706 and up with **Max Pro 1000 heavy duty motor disk scrub heads**.

Circuit Breaker	Rating	Circuit Protected
CB6	45	Right Scrub Motor
CB7	45	Left Scrub Motor
CB13	Open	

This chart shows the magnetic circuit breakers used on machines serial number 001706 and up with **Max Pro 1200 disk scrub heads**.

Circuit Breaker	Rating	Circuit Protected
CB6	40	Right Scrub Motor
CB7	40	Left Scrub Motor
CB13	40	Center Scrub Motor

This chart shows the magnetic circuit breakers used on machines with an **ec-H2O system**.

Circuit Breaker	Rating	Circuit Protected
CB16	2.0	Water Valve
CB17	2.0	ec-H2O Module
CB18	2.0	Solution Pump

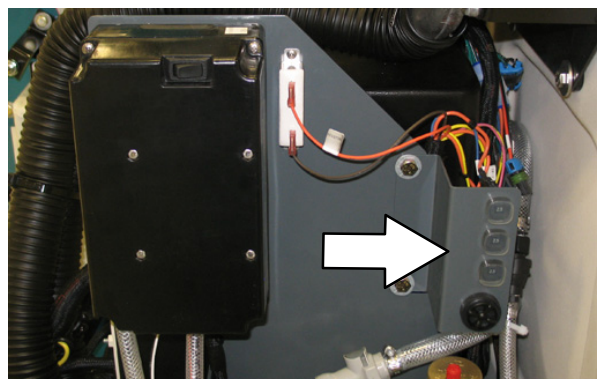
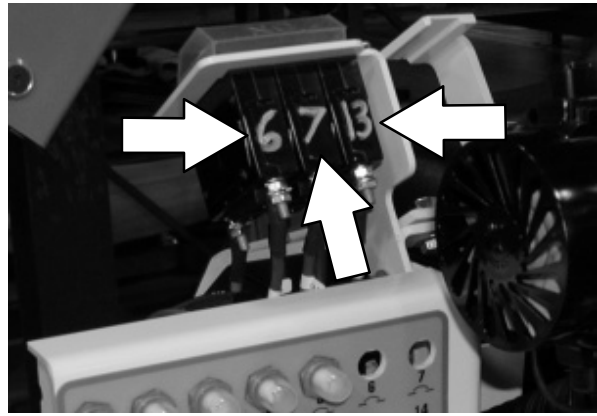

SOLUTION TANK DRAIN HOSE (OPTION)

The solution tank drain hose is used to drain the solution tank after using the ES system. Drain the solution tank by removing the drain hose cap from the tank access cap. Pull out the solution tank hose and remove the drain hose end cap.

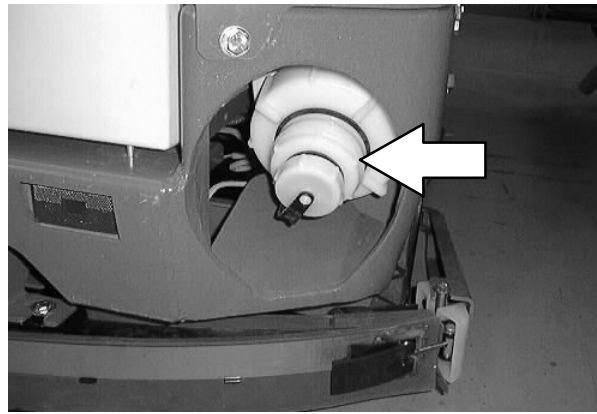

RECOVERY TANK DRAIN HOSE

The recovery tank drain hose is used to drain the recovery tank. Drain the recovery tank by removing the drain hose cap from the tank access cap. Pull out the recovery tank hose and remove the drain hose end cap.

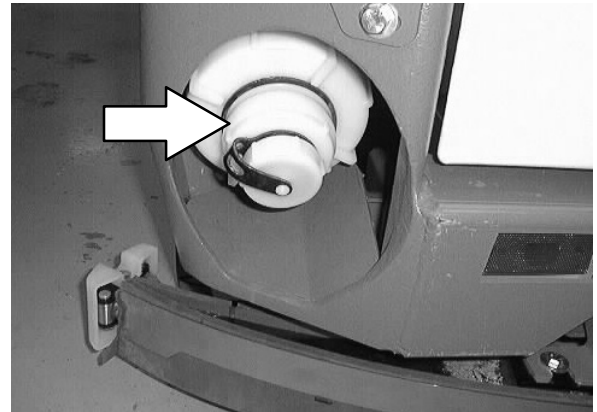

POSITIVE SOLUTION CONTROL DRAIN (OPTION)

For machines with the positive solution control drain option, remove the dust cap. Connect the drain hose to the solution control drain and open the drain valve by pulling the lever.

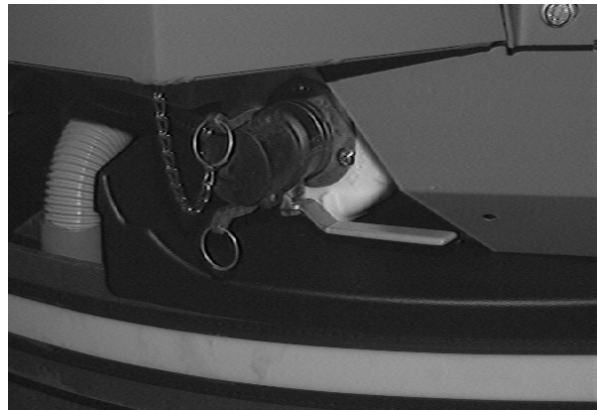

LATCHES

The front machine cover is secured with a latch.

Open: Press the raised part of the latch.

Close: Press the flat part of the latch.

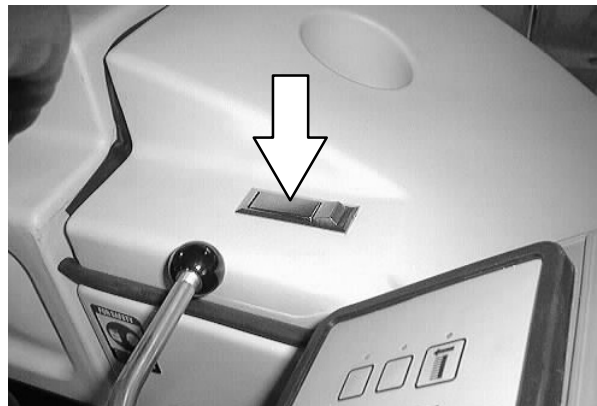

OPERATION

OPERATOR SEAT

The operator set is a fixed back style with a forward-backward adjustment.

Adjust: Pull the lever outward and slide the seat to the desired position, then release the lever.



DELUXE SUSPENSION SEAT (OPTION)

The deluxe suspension seat has four adjustments. The adjustments are for the lumbar support, backrest angle, operator weight adjustment and front to back adjustment.

The lumbar adjustment knob controls the firmness of the lumbar support.

Increase firmness: Turn knob clockwise.

Decrease firmness: Turn knob counterclockwise.



The back rest angle knob adjusts the angle of the back rest.

Increase angle: Turn the angle adjustment knob counterclockwise.

Decrease angle: Turn the angle adjustment knob clockwise.



The weight adjustment knob controls the firmness of the operator's seat.

Increase firmness: Turn the weight adjustment knob clockwise.

Decrease firmness: Turn the weight adjustment knob counterclockwise.

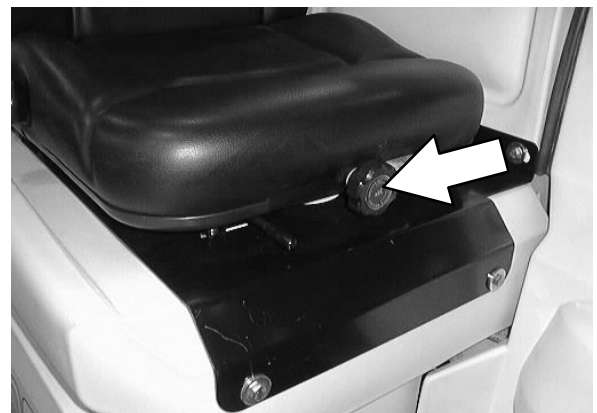

Use the gauge next to the weight adjustment knob to help determine proper seat firmness for the operator.

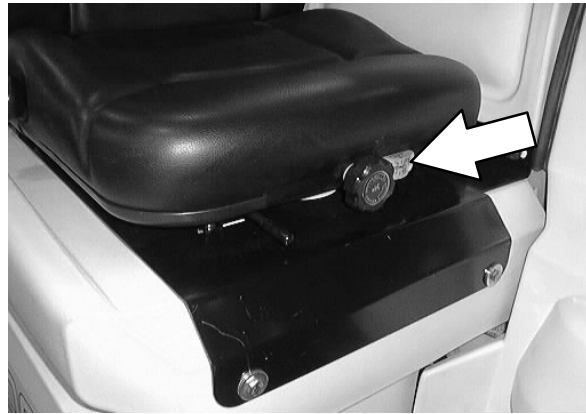

The front-to-back adjustment lever adjusts the seat position.

Adjust: Pull the lever out and slide the seat forward or backward to the desired position. Release the lever.



SIDE BRUSH ADJUSTMENT KNOB (OPTION)

The *side brush adjustment knob* controls the amount of contact the side brush has with the surface being swept.

Increase: Turn the *side brush adjustment knob* counter-clockwise.

Decrease: Turn the *side brush adjustment knob* clockwise.

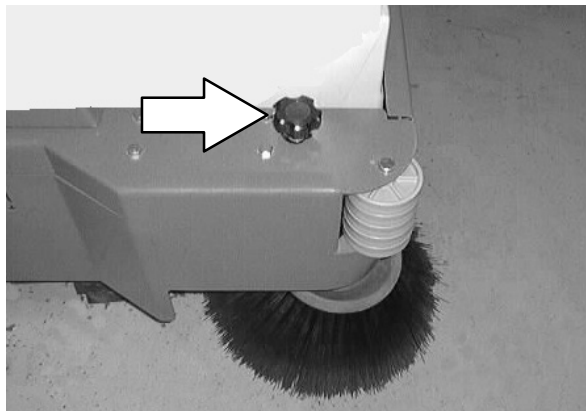

HOW THE MACHINE WORKS

The steering wheel controls the direction of machine travel. The directional pedal controls the speed and forward/reverse directions. The brake pedal slows and stops the machine.

The scrub components of the machine are a solution tank, scrub brushes, rear and side squeegees, a vacuum system, and a recovery tank.

Water and detergent, from the solution tank, flow to the floor through a solution valve to the scrub brushes. The brushes scrub the floor. As the machine is moved forward, the squeegees wipe the dirty solution off the floor, which is then picked up and drawn into the recovery tank.

The optional side brush(es), available only on the cylindrical scrub head machines, sweep light debris into the scrubbing path of the machine. The scrub brushes sweep the debris into the debris trough.

When using the ES mode (option), the solution in the recovery tank is filtered and returned to the solution tank to be reused.

The five available scrub head types use disk or cylindrical brushes.

Two different widths of scrub heads are available for each type.

The MaxPro 1000 disk scrub head contains two disk scrub brushes, and is available with standard or heavy duty scrubbing motors. The MaxPro 1000 disk scrub head is 1016 mm (40 in).

The MaxPro 1200 disk scrub head contains three disk scrub brushes, and is 1220 mm (48 in).

The MaxPro 1000 cylindrical scrub head is 1016 mm (40 in).

The MaxPro 1200 cylindrical scrub head is 1220 mm (48 in).

NOTE: The amount and type of soilage play an important role in determining the type of brushes to be used. For specific recommendations, contact your Tennant representative.

When finished scrubbing, drain and clean the recovery tank. If using the ES system (option), drain and clean the solution tank, and clean the ES filter.



FaST SCRUBBING SYSTEM

Unlike conventional scrubbing, the FaST (Foam Scrubbing Technology) system operates by injecting the FaST PAK concentrate agent into the system with a small amount of water and compressed air. This mixture creates a large volume of expanded wet foam.

The expanded foam mixture is then dispersed onto the floor while the machine is scrubbing. When the squeegee picks up the mixture, the patented foaming agent has collapsed and is recovered into the recovery tank.

The FaST system can be used with all double scrubbing and heavy duty scrubbing applications.

Using the FaST system can increase productivity by 30% by reducing your dump/fill cycle. It will also reduce chemical usage and storage space. One FaST PAK of concentrated agent can scrub up to 1 million sq. ft.

NOTE: Do not use the FaST system with conventional cleaning detergents in the solution tank. Drain, rinse and refill the solution tank with clear cool water before operating the FaST system. Conventional cleaning detergents and restorers may cause a FaST system failure.

NOTE: Storing or transporting machines equipped with the ES or the FaST system in freezing temperatures requires special procedures. Consult a TENNANT representative for more information.

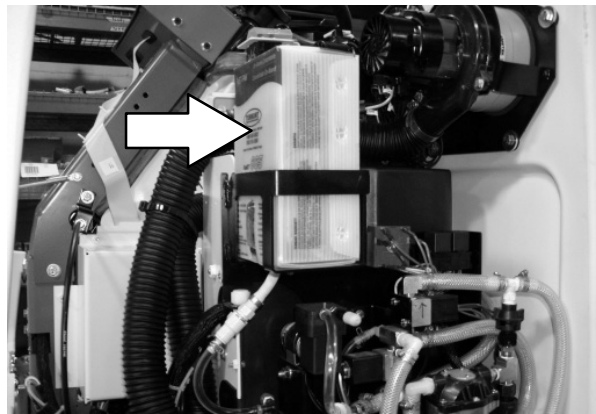

OPERATION

ec-H₂O SYSTEM (OPTION)

The *ec-H₂O* (electrically converted water) system operates by producing electrically converted water for cleaning.

Normal water passes through a module where it is oxygenated and charged with an electric current. The electrically converted water changes into a blended acidic and alkaline solution forming a neutral pH cleaner. The converted water attacks the dirt, breaks it into smaller particles, and pulls it off the floor surface allowing the machine to easily scrub away the suspended soil. The converted water then returns to normal water in the recovery tank.

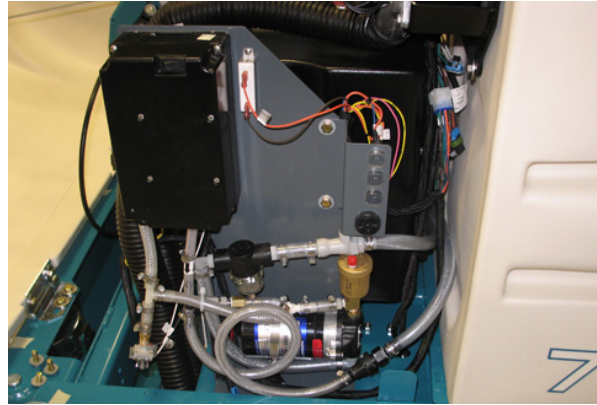

The *ec-H₂O* system can be used with all double scrubbing applications.

NOTE: Do not enable the ec-H₂O system with conventional cleaning detergents in the solution tank. Drain, raise and refill the solution tank with clear cool water only before operating the ec-H₂O system. Conventional cleaning detergents/restorers may cause failure to the ec-H₂O solution system.

NOTE: Storage or transporting machines equipped with ec-H₂O in freezing temperatures requires special procedures. Follow the freeze protection procedure located in the STORAGE INFORMATION section.

PRE-OPERATION CHECKLIST

Check over this list of items before operating the machine:

- Check the hydraulic fluid level. (if applicable)
- Check the battery fluid and charge level.
- Check the tank cover seals for damage and wear.
- Clean the vacuum fan inlet filter.
- Check the condition of the scrubbing brushes. Remove any string, banding, plastic wrap, or other debris wrapped around them.
- Check the squeegees for damage, wear and for deflection adjustment.
- Check the vacuum hose for debris or blockage.
- ES machines; check the detergent tank level.
- Drain and clean the recovery tank.
- ES machines; drain and clean the solution tank and ES filter. Rinse level sensors.
- Check the brakes and steering for proper operation.
- Empty and clean the debris tray. (if applicable).
- Check the service records to determine maintenance requirements.
- FAST Scrubbing: Check the FaST PAK concentrate agent level, replace carton as needed. See the INSTALLING THE FaST PAK AGENT section of the manual.
- For FaST or *ec-H₂O* Scrubbing: Check that all conventional cleaning agents/restorers are drained and rinsed from the solution tank.
- For FaST or *ec-H₂O* Scrubbing: Check that the solution tank is filled with **clear cool water only**.

INSTALLING FaST PAK AGENT

NOTE: Machine must be equipped with FaST before the FaST PAK agent can be installed.

1. Turn the machine power off.

FOR SAFETY: Before leaving or servicing machine, stop on level surface, set parking brake, turn off machine, and remove key.

2. Remove the perforated knock-outs from the FaST PAK Floor Cleaning Concentrate carton. Do not remove the bag from the carton. Pull out the bag's hose connector on the bottom of the bag and remove the hose cap from the connector.

NOTE: The FaST PAK Floor Cleaning Concentrate is specifically designed for use with the FaST system scrubbing application. NEVER use a substitute, machine damage will result.

FOR SAFETY: When using machine, always follow the handling instructions on chemical container.

3. Empty the solution tank. See the DRAINING AND CLEANING THE TANKS section of the manual.

NOTE: When scrubbing with the FaST system option, use clean water only. Do not add cleaning agents in the solution tank. Conventional cleaning agents/restorers may cause failure to the FaST solution system..

4. Raise the front cover to access the FaST PAK carton.

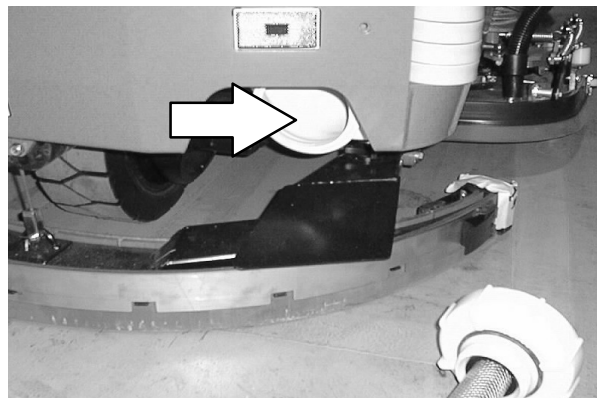

5. Place the FaST PAK carton in the carton holder under the front cover of the machine. Connect the supply hose to the FaST PAK bag.

NOTE: If any dried concentrate is visible on the supply hose connector or the on the FaST PAK connector, soak and clean with warm water.



6. Make sure to connect the supply hose onto the hose storing plug when the supply hose is not connected to the FaST PAK. This will prevent the FaST solution system from drying out and clogging up the hose.

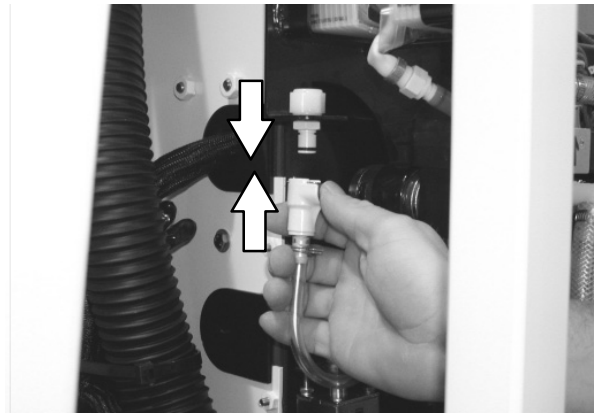

7. The FaST solution system must be primed for first time use only. To prime system, unplug the electrical connector from the solution pump, and operate the machine in the FaST Scrub Mode for seven to ten minutes. Reconnect the solution pump connector.
8. When replacing an empty FaST PAK carton, allow the new FaST PAK detergent to gravity feed into the system for several minutes prior to operating the FaST system. If the detergent does not flow out of the FaST PAK, simply squeeze and release the hose several times. If the previous FaST PAK was run dry, it may take up to 7-10 minutes of operation to remove any air pockets in the system before you achieve maximum foaming.

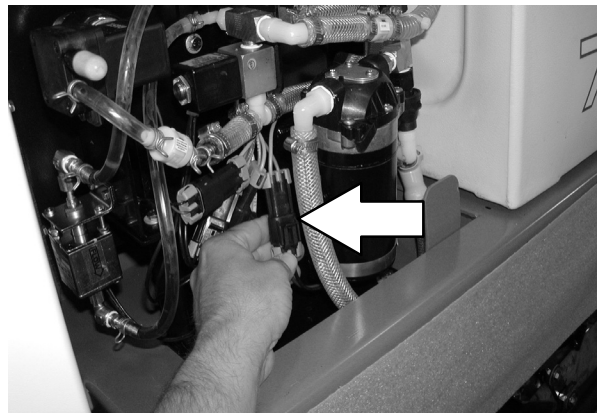

OPERATION

STARTING THE MACHINE

1. You must be in the operator's seat with the directional pedal in neutral, and your foot on the brake pedal or with the parking brake set.

FOR SAFETY: When starting machine, keep foot on brake and directional pedal in neutral.

2. Turn the machine power on.

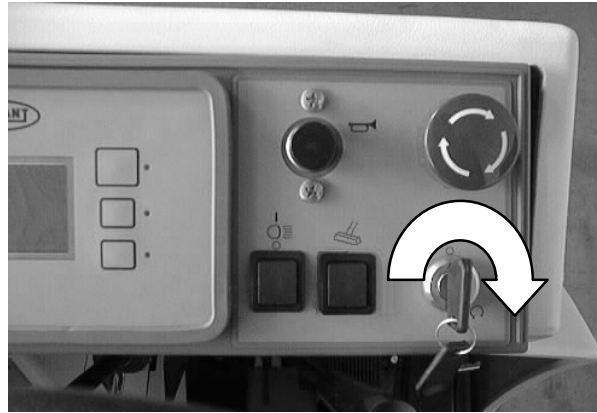

3. Release the machine parking brake.

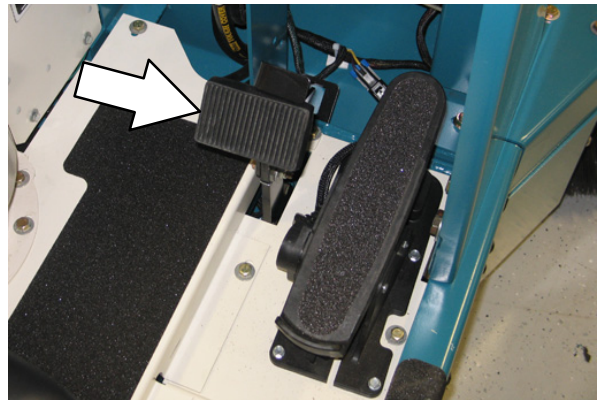

4. Drive the machine to the area to be cleaned.

FILLING THE TANKS

1. Turn the machine power on.

FOR SAFETY: When starting machine, keep foot on brake and directional pedal in neutral.

2. Drive the machine to the filling site.

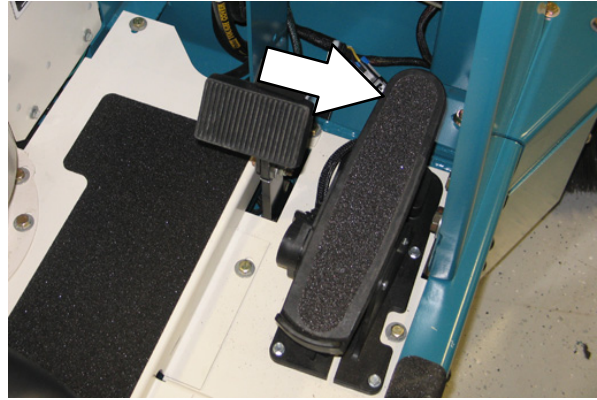

3. Turn the machine power off.

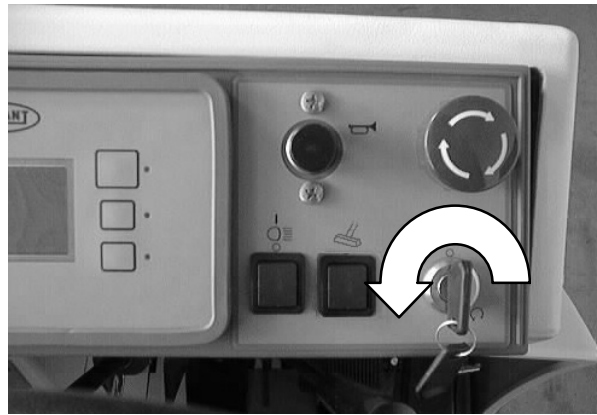

4. Set the parking brake.

FOR SAFETY: Before leaving or servicing machine; stop on level surface, set parking brake, turn off machine and remove key.

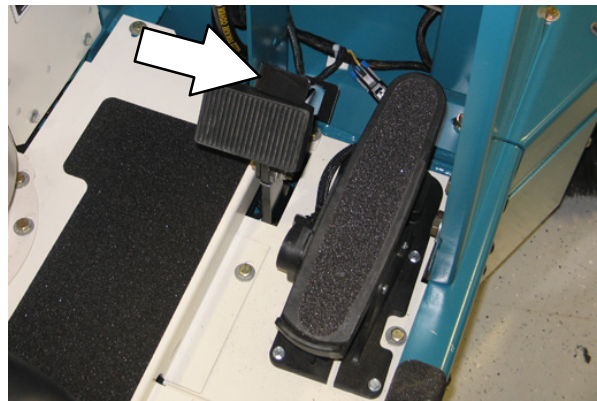

OPERATION

5. **CONVENTIONAL SCRUBBING:** Open the solution tank cover. Measure and pour in the correct amount of detergent. Fill the rest of the solution tank with water up to the FULL line near the top of the tank.

NOTE: Floor conditions, water condition, amount of soilage, types of soilage, and brush action all play an important role in determining the type and concentration of detergent used. For specific recommendations, contact your Tennant representative.



WARNING: Flammable materials can cause an explosion or fire. Do not use flammable materials in tank(s).

FOR SAFETY: When using machine, follow mixing and handling instructions on chemical containers.

6. **FaST or ec-H₂O SCRUBBING:** Open the solution tank cover and fill the solution tank with clear cool water only.

NOTE: When cleaning using the FaST or ec-H₂O option, USE CLEAR COOL WATER ONLY. DO NOT add cleaning agents in solution tank. Conventional cleaning agents/restorers may cause failure to the system.

7. **ES MODE:** Remove the detergent tank (option) lid. Fill the tank almost to the top. Be sure to use only the proper detergent for your scrubbing application. Put the lid back on the detergent tank.



WARNING: Flammable materials can cause an explosion or fire. Do not use flammable materials in tank(s).

NOTE: Floor conditions, water condition, amount of soilage, type of soilage, and brush action all play an important role in determining the type and concentration of detergent used. For specific recommendations, contact your TENNANT representative.

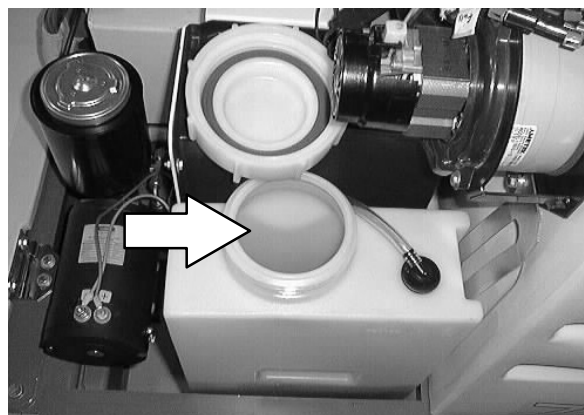

8. ES mode *with* auto fill : Connect the hose from the water source to the auto-fill connection on the machine. Turn the machine power on, and turn on the water source. The auto-fill will automatically fill the tanks to the proper level for ES operation and automatically shut-off.

NOTE: An alarm will sound when the solution tank is full.

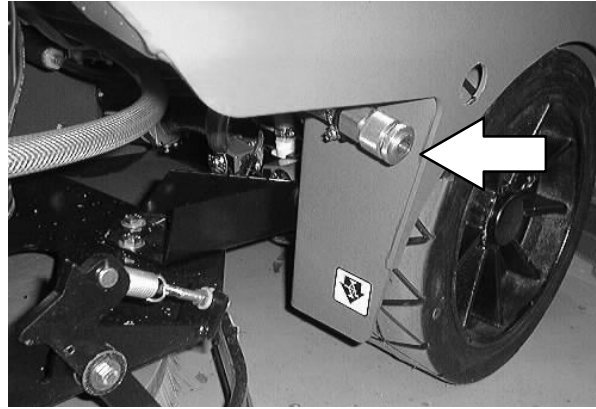

NOTE: If you DO NOT want to use the ES system, DO NOT put water in the recovery tank. Turn the ES™ switch OFF.

9. Close the solution tank cover.

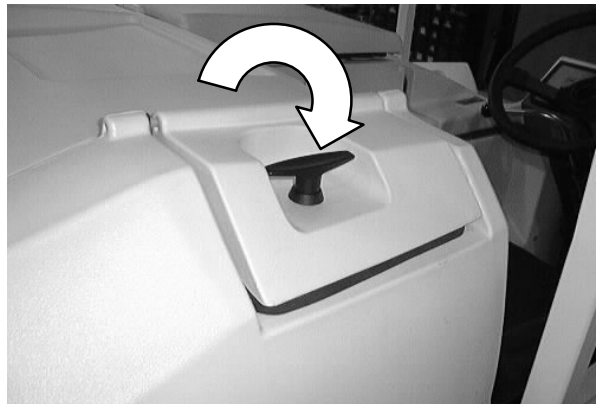

SWEEPING, SCRUBBING AND BRUSH INFORMATION

Pick up oversized debris before cleaning. Pick up pieces of wire, string, twine, etc., which could become wrapped around the sweeping or scrubbing brushes.

Optional side brush sweeping is available only on the cylindrical scrub head machines.

Plan the sweeping and scrubbing in advance. Try to arrange long runs with minimum stopping and starting. Sweep debris from very narrow aisles into main aisles ahead of time. Do an entire floor or section at one time.

Drive as straight a path as possible. Avoid bumping into posts or scraping the sides of the machine. Overlap the scrub paths by several centimeters (a few inches).

Avoid turning the steering wheel too sharply when the machine is in motion. The machine is very responsive to the movement of the steering wheel. Avoid sudden turns, except in emergencies.

When scrubbing dead end aisles, start at the closed end of the aisle and scrub your way out.

Adjust the machine speed, scrub brush pressure, and solution flow as required when scrubbing. Use minimum scrub brush pressure and solution flow required for the best results. The machine has an edge clean feature for all MaxPro™ 1000 scrub heads, for scrubbing against an edge.

If you see poor scrubbing performance, stop scrubbing and refer to *MACHINE TROUBLESHOOTING*.

For best results, use the correct brush type for your cleaning application. The following are recommended brush applications.

Polypropylene side sweeping brush – A general purpose brush for sweeping light to medium debris in both indoor and outdoor applications. This brush is recommended in places where the bristles may get wet.

Non-scuff polypropylene scrub brush – This brush uses a softer, general purpose polypropylene bristle to lift lightly compacted soilage without scuffing high-gloss coated floors.

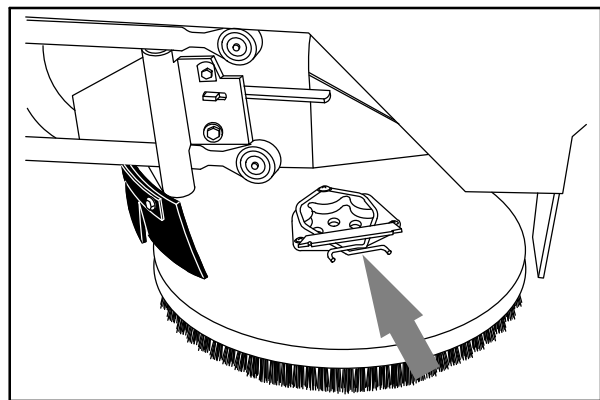

05939

Nylon scrub brush – Recommended for scrubbing coated floors. Cleans without scuffing.

Super abrasive bristle scrub brush – Nylon fiber impregnated with abrasive grit to remove stains and soilage. Strong action on any surface, performing well on buildup, grease, or tire marks.

Stripping pad – This brown pad is for stripping floors. Quickly and easily cuts through old finish to prepare the floor for re-coating.

Surface preparation pad – This maroon pad is for very aggressive stripping without chemicals.

Scrubbing pad – This blue pad is for scrubbing floors. Removes dirt, spills and scuffs, leaving a clean surface ready for re-coating.

Buffing pad – This red pad is for buffing floors. Quickly cleans and removes scuff marks while polishing the floor to a high gloss.

Polishing pad – This white pad is for polishing floors. Maintains a high gloss. Use for buffing very soft finishes and lower traffic areas, or use for polishing soft waxes on wood floors.

Cylindrical polypropylene scrub brush – This cylindrical brush uses a softer, general purpose polypropylene bristle to lift lightly compacted soilage without scuffing high-gloss coated floors.

Cylindrical nylon scrub brush – This cylindrical brush is recommended for scrubbing coated floors. Cleans without scuffing.

Cylindrical super abrasive bristle scrub brush – Nylon fiber impregnated with abrasive grit to remove stains and soilage. Strong action on any surface, performing well on buildup, grease, or tire marks.

NOTE: Cylindrical scrub brushes must be installed with the herringbone patterns on the brushes pointing towards each other for best debris pick up.

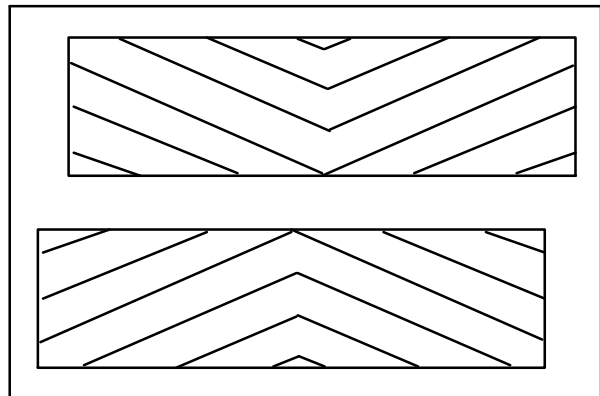

OPERATION

SCRUBBING

1. Start the machine.

FOR SAFETY: When starting machine, keep foot on brake and directional pedal in neutral.

2. Drive the machine to the area to be cleaned.

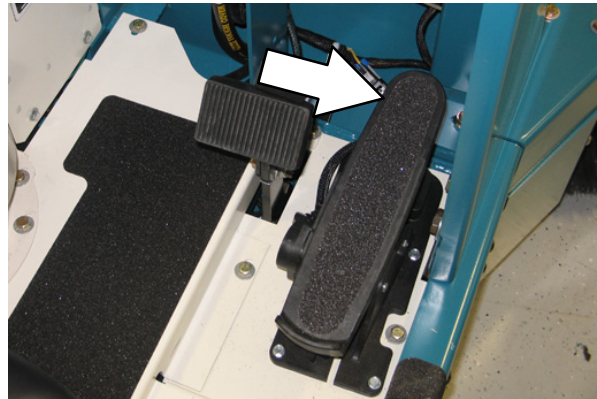

3. FaST SCRUBBING: Press the FaST switch to the desired solution flow. See the FaST SWITCH section of the manual.

NOTE: Leave the FaST switch in the CONVENTIONAL SCRUBBING position if not using the FaST system.

ec-H2O Scrubbing: Press the ec-H2O switch to the desired solution flow. See the ec-H2O SWITCH section of the manual.

NOTE: The ec-H2O system indicator light will not turn on until the machine starts scrubbing.

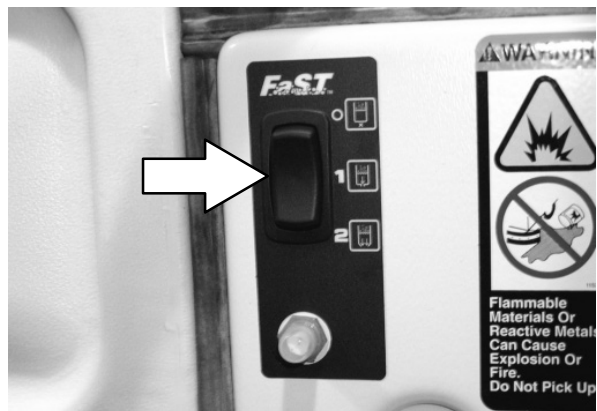

ec-H2O Model: If an alarm sounds and the ec-H2O system indicator light begins to blink red, the ec-H2O module must be flushed to resume ec-H2O operation (See ec-H2O MODULE FLUSH PROCEDURE).

NOTE: When the alarm sounds and the light blinks red, the machine will bypass the ec-H2O system. To continue scrubbing, press the ec-H2O switch to conventional scrubbing.



ATTENTION: (*ec-H2O* model) Do not allow solution tank to run dry. *ec-H2O* module failure may result if operated without water for an extended period.

<i>ec-H2O</i> SYSTEM INDICATOR LIGHT CODE	CONDITION
Solid green	Normal operation
Blinking red	Flush <i>ec-H2O</i> module
Solid red	Contact Service Center

4. CONVENTIONAL SCRUBBING: Adjust the solution flow to the floor as needed.

NOTE: When using the FaST or ec-H2O system (option), the solution flow lever is nonfunctional. The FaST and ec-H2O system flow rates are pre-set. The ec-H2O module has optional flow rate settings. If solution flow adjustments are required, contact an Authorized Service Center.

Increase flow: Raise the lever up. Use this flow rate for rough floors and heavy or compacted dirt.

Decrease flow: Lower the lever down. Use this flow rate for smooth floors and light dirt.

Stop flow: Lower the lever all the way down.

NOTE: For machines equipped with cylindrical scrub heads, decrease solution flow rate when turning.



OPERATION

5. Press the scrub switch to start the scrubbing operations. See the SCRUB SWITCH section of the manual

WARNING: Flammable materials or reactive metals can cause explosion or fire. Do not pick up.

As long as the machine is moving forward the scrub head will lower and the scrub brushes will start. The optional sweeping side brush(es) will lower and start. The rear squeegee will lower and the vacuum fan will start. The solution system will start when the machine first begins to move forward, but only if the solution flow lever is on. The detergent pump will start and the optional FaST, *ec-H2O*, or ES systems if the switches are on.

NOTE: The scrub head and optional sweeping side brush(es) will raise when the directional pedal is in the neutral or reverse position. The rear squeegee will raise when the directional pedal is in the reverse position.

NOTE: If an excess of water in the recovery tank triggers the 'tank full' switch, a tank full alarm will sound for ten seconds and a tank full icon will appear on the control panel. All scrubbing functions will be canceled. To make the overflow icon disappear, drain the recovery tank, then press the scrub switch.

NOTE: A low battery and a no brush current sensed will also cancel the scrub system.

6. Adjust brush pressure for cleaning application. See the SCRUB SWITCH section of the manual.

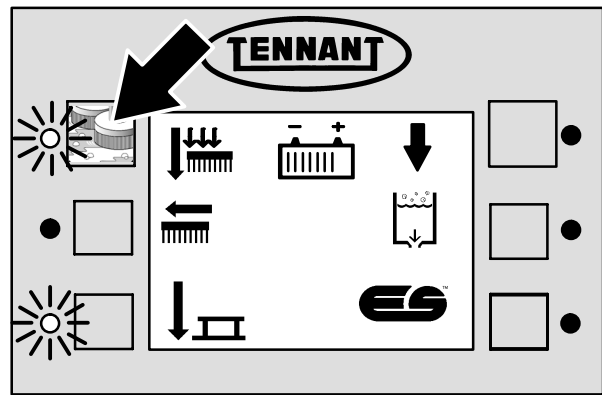
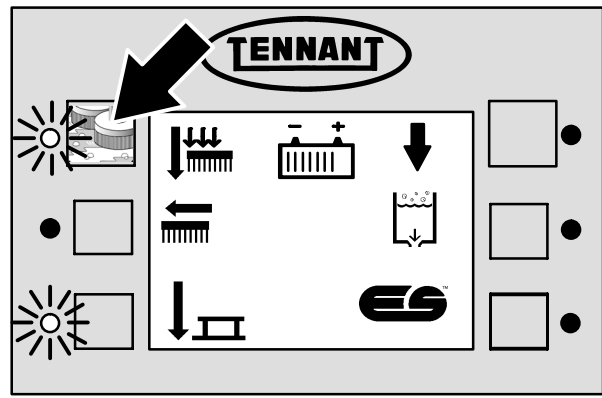

- Press the edge scrub switch if edge scrubbing is necessary.

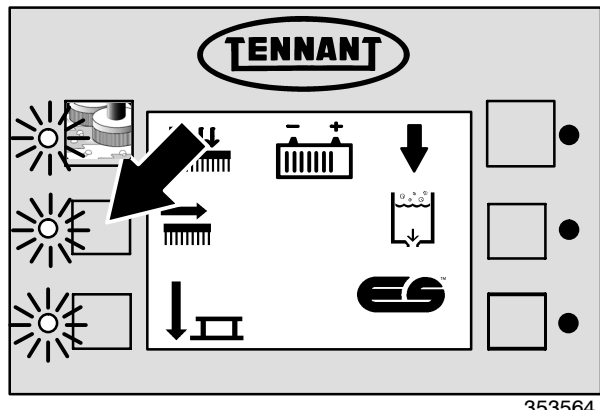

- Adjust detergent flow with detergent flow switch (option).

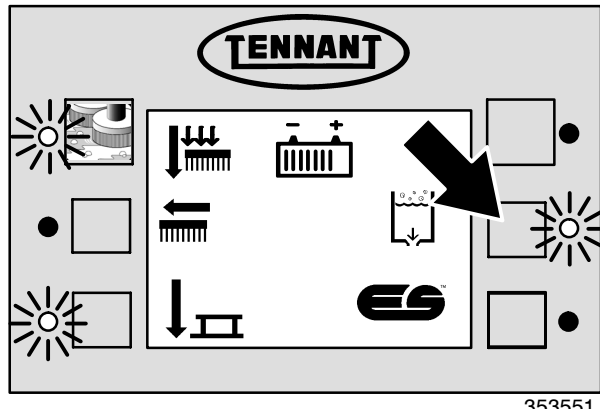

- Press the ES switch (option) if extended scrubbing is necessary.

NOTE: When using the ES (option), the recovery tank 1/2 full float must be active for the pump to operate.

NOTE: A full solution tank will turn off the ES pump

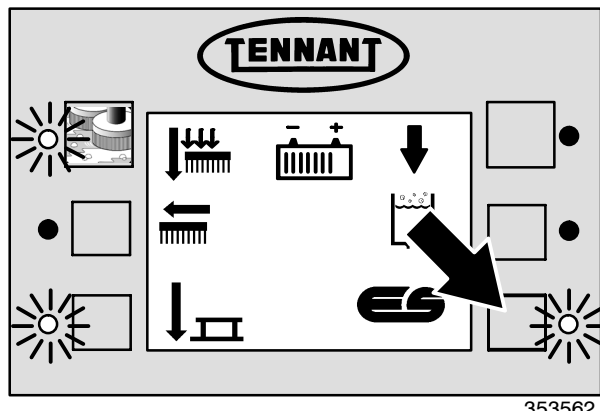

*NOTE: If you **do not** want to use the ES system, make sure the indicator next to the ES switch is off.*

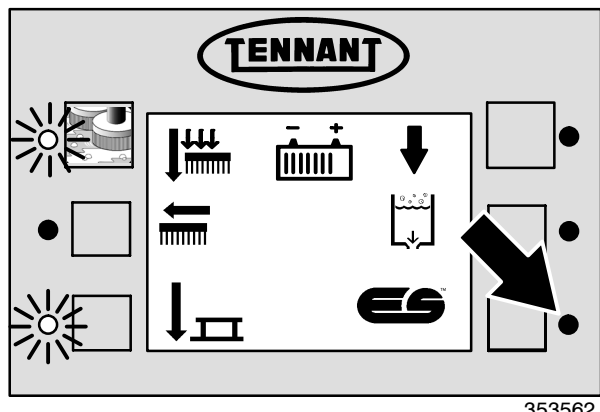

OPERATION

On machines equipped with the optional sweeping side brush, (available only on cylindrical scrub head machines) the sweeping brush(es) will start when the scrub switch is pushed.

10. Press the side brush switch to turn off the side brush if sweeping is not desired. Make sure the indicator next to the side brush switch is off. See the SIDE BRUSH SWITCH section of the manual.

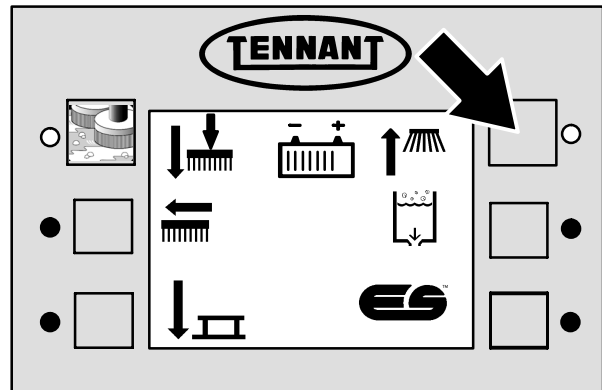

11. Press the side brush button again to restart the side brushes as needed while scrubbing.

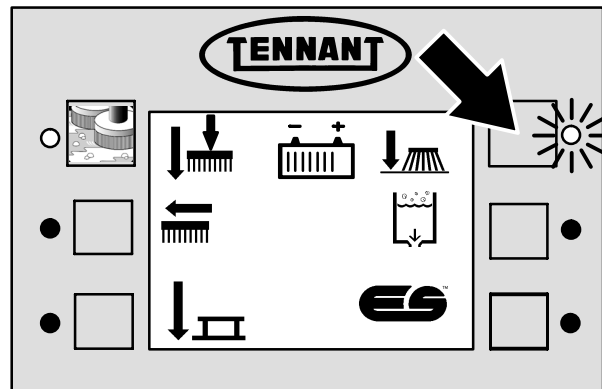

12. Drive the machine forward and scrub as required.

 **WARNING: Flammable materials or reactive metals can cause explosion or fire. Do not pick up.**

DOUBLE SCRUBBING

Double scrubbing is the process of making two or more passes over a heavily soiled area. The first pass is made with the rear and side squeegees raised to allow the solution to soak into the floor.

Double scrubbing can be performed using the FaST SCRUBBING SYSTEM (option), ec-H₂O SCRUBBING SYSTEM (option) or CONVENTIONAL SCRUBBING methods.

Use the maximum solution and detergent flow settings. Use a higher brush pressure setting. Let the solution remain on the floor for 5 to 15 minutes, then make a second scrubbing pass with the rear and side squeegees down.

NOTE: When using the FaST or ec-H₂O system (option), the solution flow lever is nonfunctional. The FaST and ec-H₂O system flow rates are pre-set. The ec-H₂O module has optional flow rate settings. If solution flow adjustments are required, contact an Authorized Service Center.

FOR SAFETY: When using machine, go slow on inclines and slippery surfaces.

STOP SCRUBBING

Press the scrub switch to stop the scrubbing operations.

The scrub brushes will stop and the scrub head will raise. The ES detergent pump (option) will stop, and the solution flow will stop, the FaST system will stop. After a short delay, the rear squeegee will automatically raise and the scrubbing vacuum fan will stop.

Continue driving the machine forward until the vacuum fan shuts off.

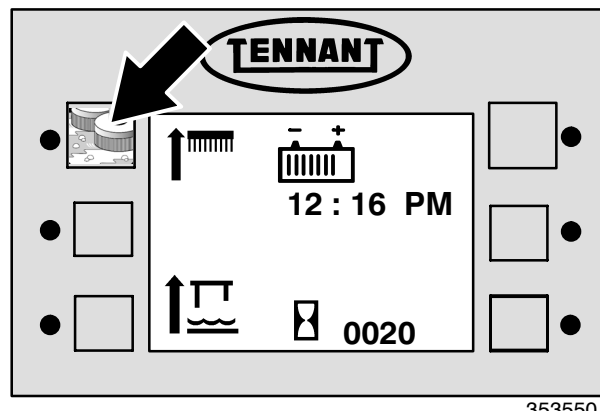

OPERATION

DRAINING AND CLEANING THE TANKS

When you are finished scrubbing, or when the recovery tank full indicator comes on, the recovery tank should be drained and cleaned. The solution tank can then be filled again for additional scrubbing.

If you used the machine in ES mode, the solution tank should also be drained and cleaned when you are finished scrubbing.

1. Stop scrubbing.
2. Drive the machine next to an appropriate disposal site.
3. Turn the machine power off.

FOR SAFETY: Before leaving or servicing machine; stop on level surface, set parking brake, turn off machine and remove key.

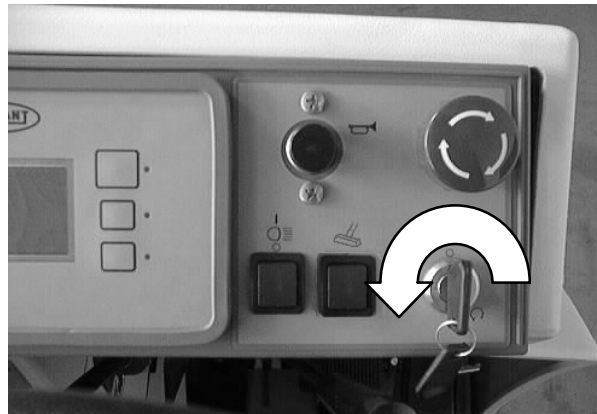

4. Set the parking brake.

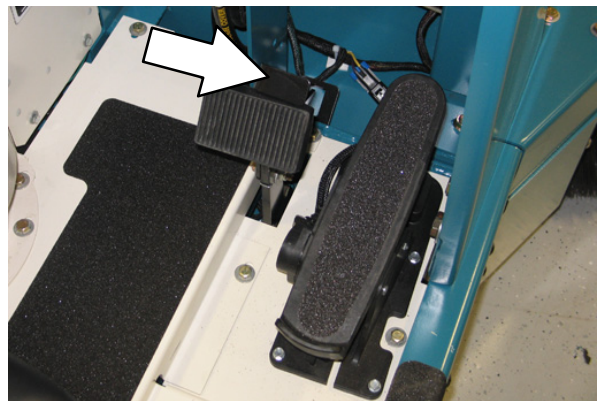

5. Unscrew the drain hose cap from the recovery tank drain access cap.
6. Pull out and place the drain hose next to the floor drain. Remove the drain end cap from the hose. Stand back because the solution rushes out of the drain hose.

ES mode: Unscrew the drain hose cap from the solution tank drain access cap and drain the solution tank.

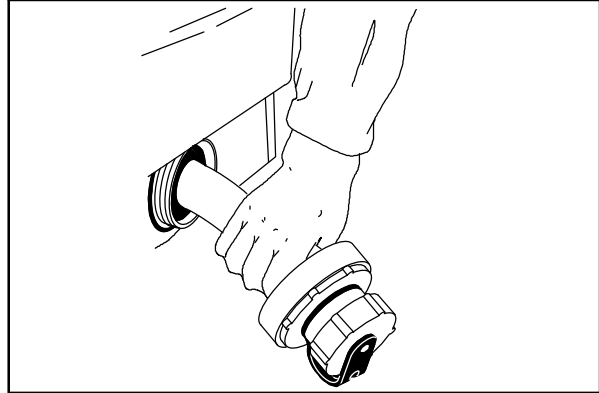

05914

For machines with the positive solution control drain option, remove the drain cap and connect the hose. Place the hose end next to the floor drain and open the drain valve by pulling the lever.

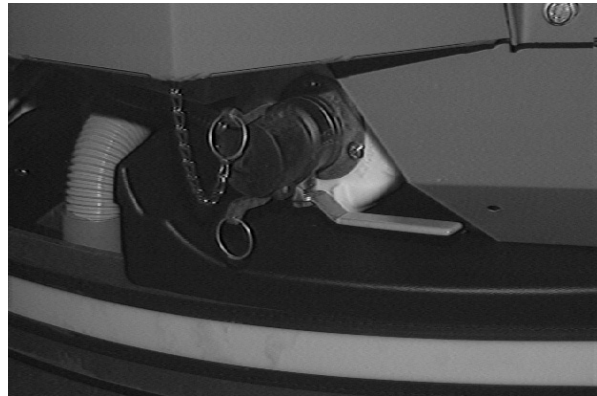

7. Open the recovery tank cover.
8. Spray the inside of the recovery tank with clean water. DO NOT allow any water to enter the vacuum fan air intake opening towards the front of the tank.

NOTE: DO NOT use steam to clean the tanks. Excessive heat can damage the tanks and components.



OPERATION

9. Remove the large drain cap and flush out the bottom on the recovery tank.

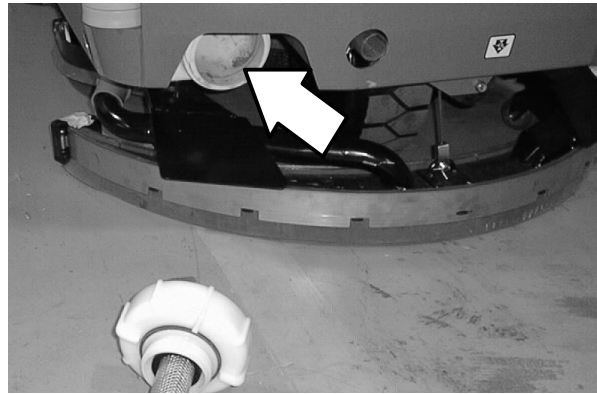

10. ES mode: Locate the ES cleanout wand under the battery cover. Remove it and attach it to a water supply hose to use for cleaning.
11. ES mode: Lift up the ES filter by the handle until the mesh is exposed and rinse it thoroughly.

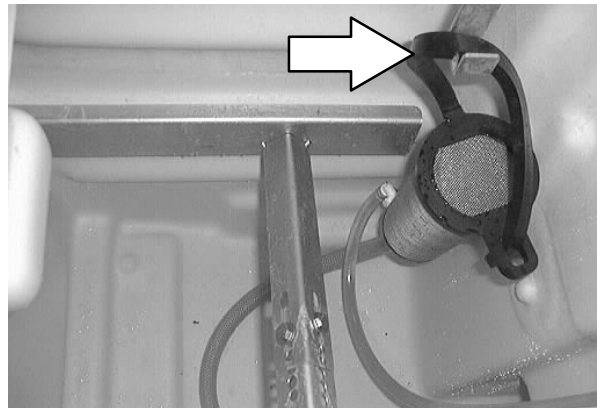

12. Rinse off the float sensor(s) on the inside of the recovery tank.



13. ES mode: Drain the solution tank. Flush out the solution tank with clean water. Rinse the solution outlet filters at the bottom of the tank through the drain access.

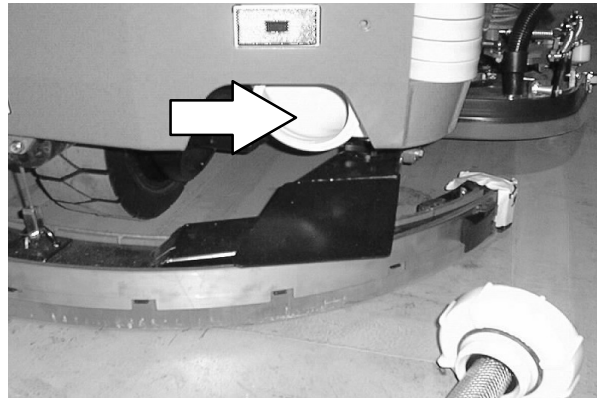

14. ES mode: Rinse the sensor float tubes near the top of the solution tank.

NOTE: DO NOT use steam to clean the tanks. Excessive heat can damage the tanks and components.

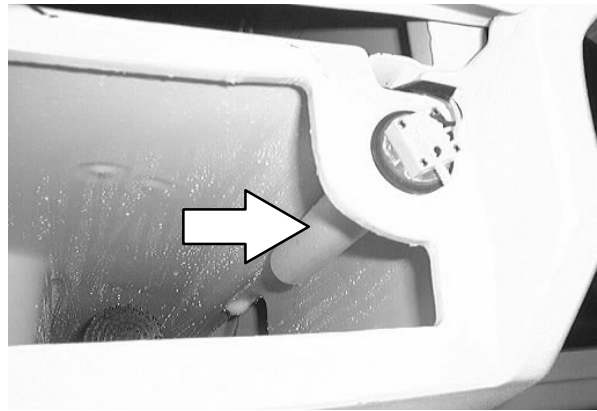

15. Cylindrical scrub head: Press down on the right side squeegee support guard latch until the right side squeegee support guard opens. Swing the squeegee support guard away from the scrub head.

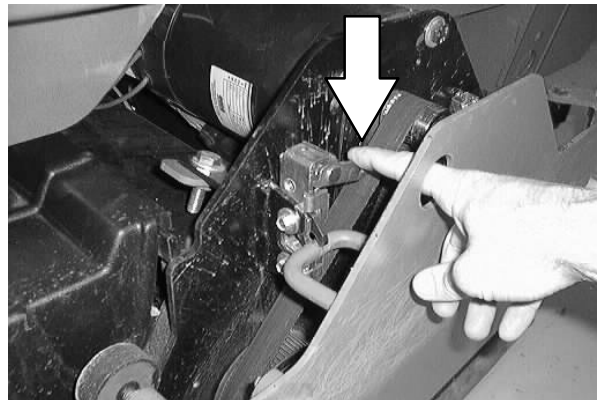

OPERATION

16. Cylindrical scrub head: Remove and clean the debris trough from the right hand side of the machine. Place the trough back in the scrub head when clean.

NOTE: The debris trough can be removed from the right hand side of the machine only.

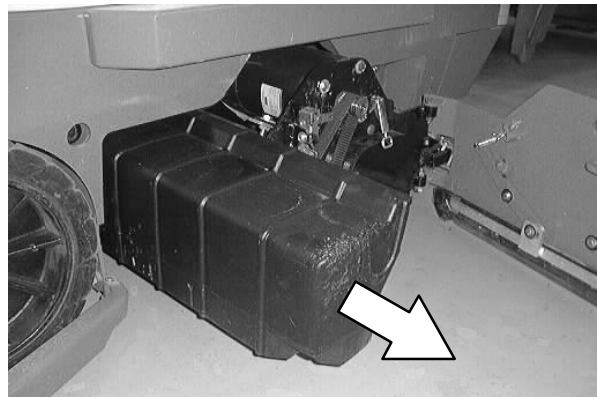

17. Remove the vacuum fan filter from the recovery tank cover.

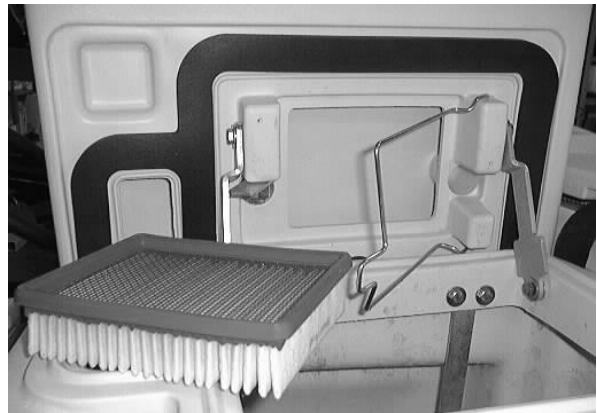

18. Clean the vacuum fan filter by using low pressure air, or rinsing pleats with low pressure water.

19. Insert the filter back into the recovery tank cover. Close the tank covers.



20. Place the drain end caps on the tank drain hoses. Push the drain hoses back into the tanks.

For machines with the positive solution control drain option, close the drain valve. Remove the hose and connect the drain cap.

STOP THE MACHINE

1. Stop scrubbing. See the STOP SCRUBBING section of the manual.
2. Take your foot off the directional pedal. Step on the brake pedal.

NOTE: The machine may coast for a short distance when your foot is removed from the directional pedal. Use the brake pedal to stop the machine.

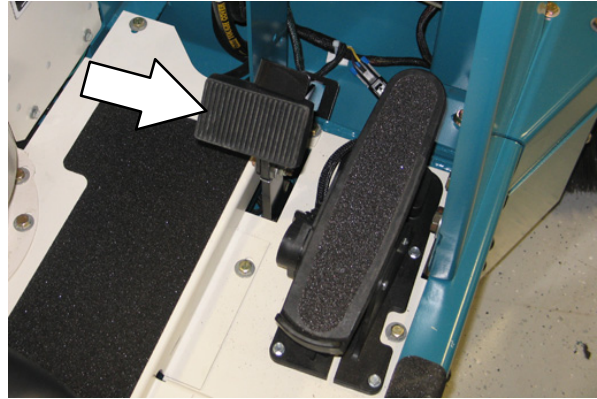

3. Turn the machine power off.

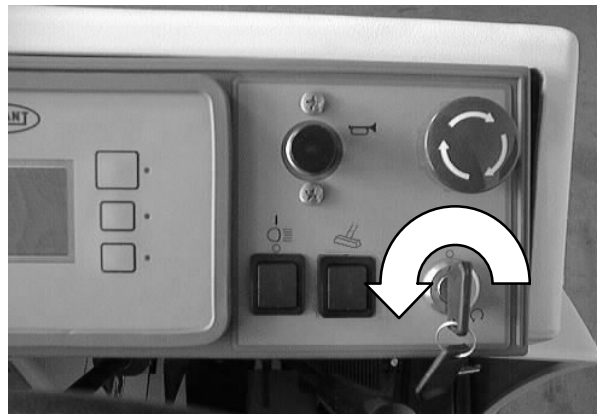

4. Set the machine parking brake.

FOR SAFETY: Before leaving or servicing machine; stop on level surface, set parking brake, turn off machine and remove key.

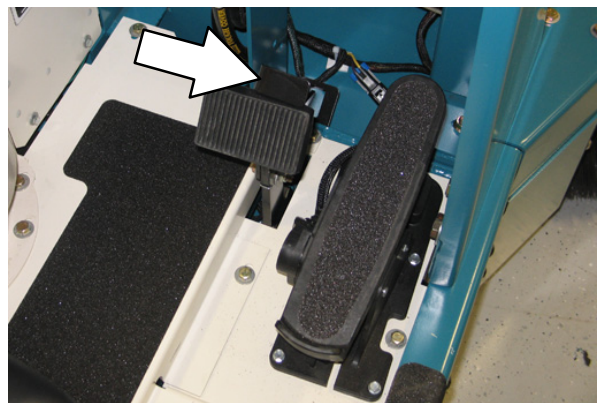

POST-OPERATION CHECKLIST

Check over this list of items after you have finished scrubbing with the machine powered on:

- Check the hydraulic fluid level. (if applicable)
- Check the battery fluid and charge level.
- Check the tank cover seals for damage and wear.
- Clean the vacuum fan inlet filter.
- Check the condition of the scrubbing brushes. Remove any string, banding, plastic wrap, or other debris wrapped around them.
- Check the squeegees for damage, wear and for deflection adjustment.
- Check the vacuum hose for debris or blockage.
- ES machines; check the detergent tank level.
- Drain and clean the recovery tank.
- ES machines; drain and clean the solution tank and ES filter. Rinse level sensors.
- Check the brakes and steering for proper operation.
- Empty and clean the debris tray. (if applicable).
- Check the service records to determine maintenance requirements.
- FaST Scrubbing: If FaST PAK is empty after scrubbing, install a new FaST PAK or connect supply hose to the storage plug.

OPERATION ON INCLINES

Drive the machine slowly on inclines.

FOR SAFETY: When using machine, go slow on inclines and slippery surfaces.

The maximum rated climb and descent incline with empty tanks is 8°, and with full tanks is 6°.

OPTIONS

VACUUM WAND

The vacuum wand uses the machine's vacuum system. The vacuum wand and hose allows pick-up of spills that are out of reach of the machine.

 **WARNING: Flammable materials or reactive metals can cause explosion or fire. Do not pick up.**

1. Turn the machine power off.

FOR SAFETY: Before leaving or servicing machine; stop on level surface, turn off machine.

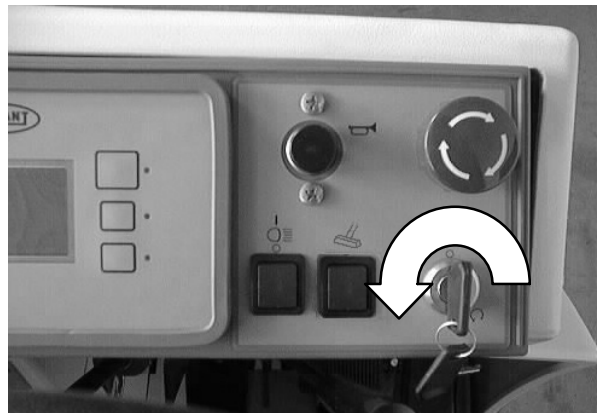

2. Set the parking brake.

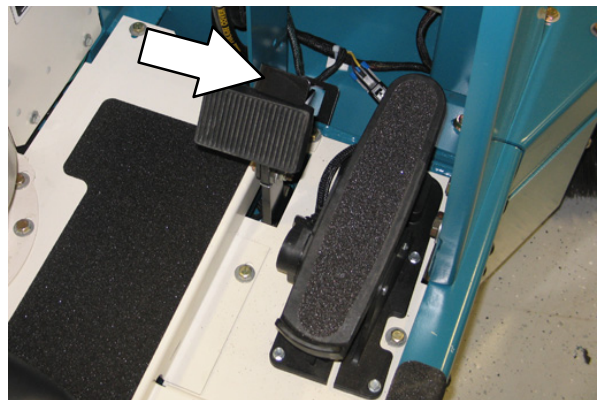

OPERATION

3. Remove the vacuum wand equipment from the tank cover.
4. Remove the squeegee suction hose from the top of the rear squeegee.

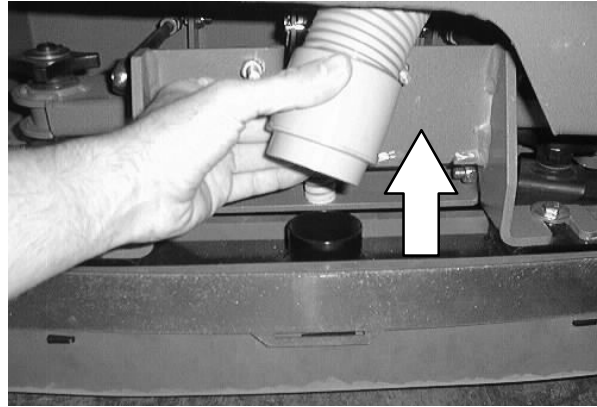

5. Connect the vacuum wand hose and the squeegee suction hose with the adapter.

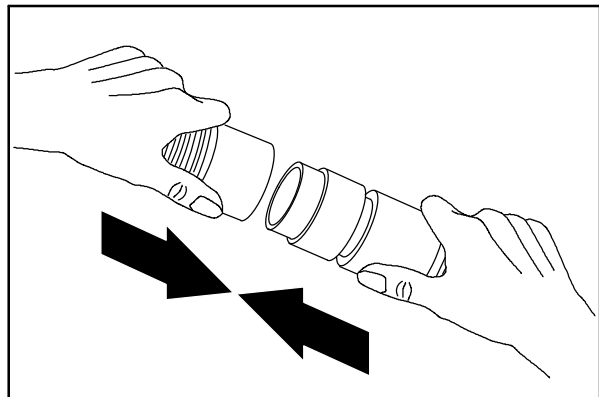

6. Put together the wand and the wand hose.

10945

7. Turn the machine power on.

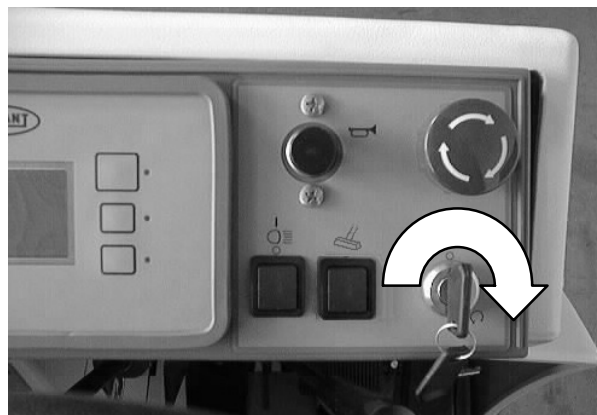

- Press the rear squeegee switch to turn on the vacuum.

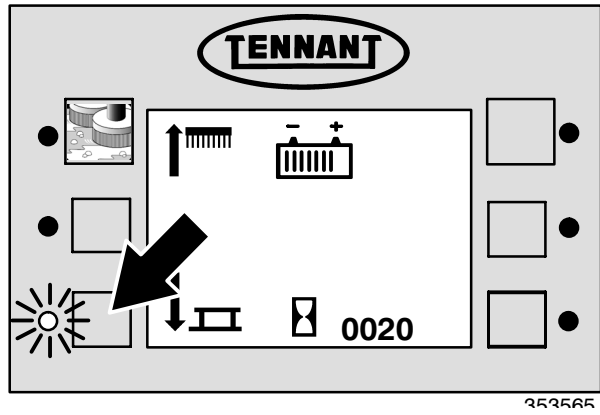

- Vacuum the floor.

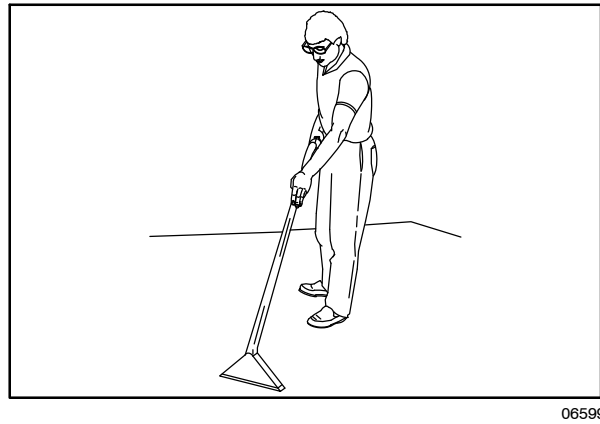

- When finished, shut off the vacuum with the rear squeegee switch.

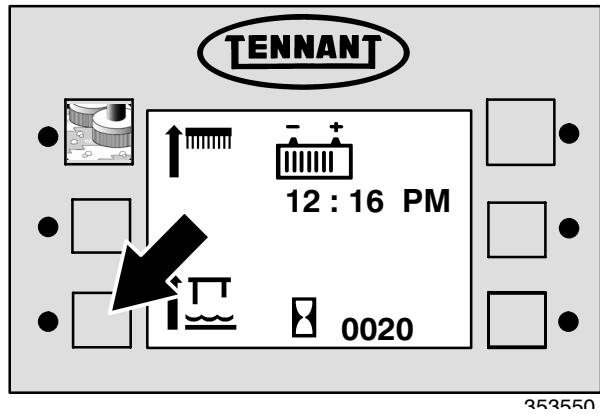

OPERATION

11. Turn the machine power off.

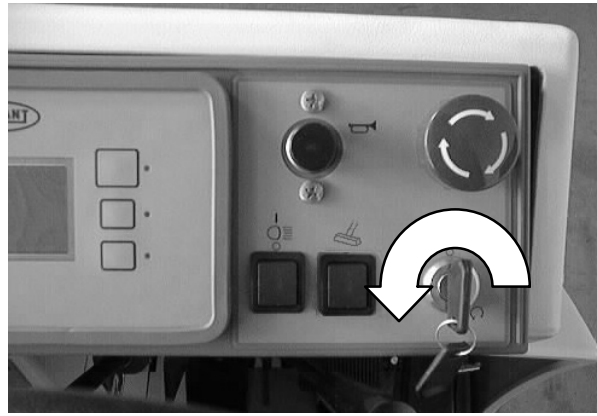

12. Disconnect the vacuum hose from the squeegee suction hose.

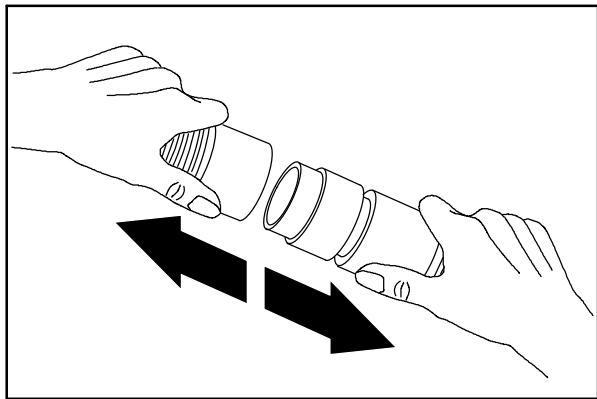

10946

13. Reconnect the squeegee suction hose to the top of the squeegee.

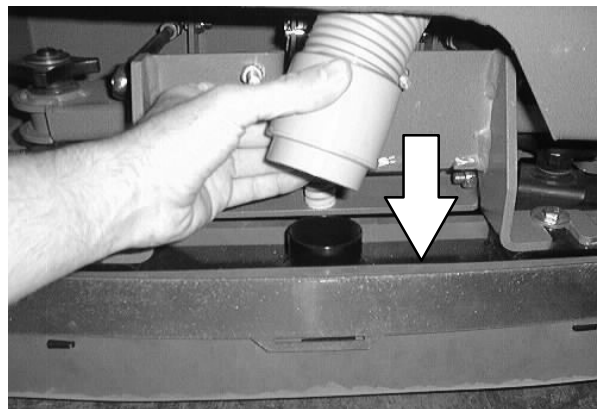

14. Clean and rinse the vacuum wand equipment.

15. Secure the vacuum wand equipment on top of the tank cover.

POWER WAND

The power wand uses the machine's vacuum and solution systems. The power wand allows scrubbing of floors that are out of reach of the machine.

⚠ WARNING: Flammable materials or reactive metals can cause explosion or fire. Do not pick up.

1. Turn the machine power off.

FOR SAFETY: Before leaving or servicing machine; stop on level surface, turn off machine.

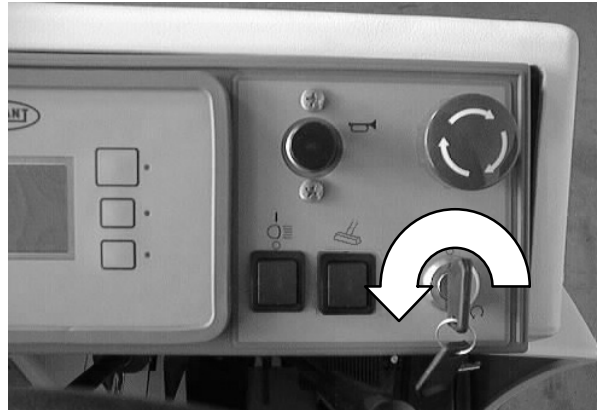

2. Set the parking brake.

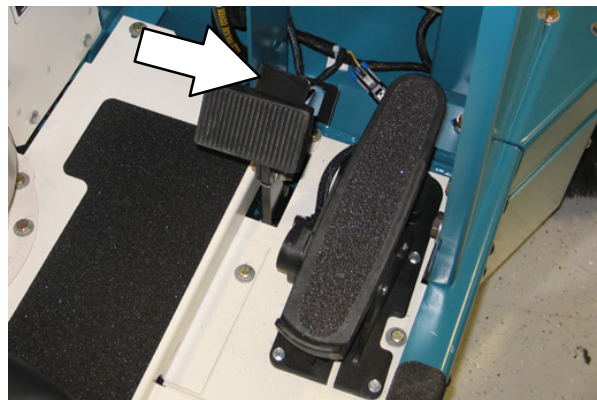

3. Remove the power wand equipment from the tank cover.

OPERATION

4. Remove the squeegee suction hose from the top of the rear squeegee.

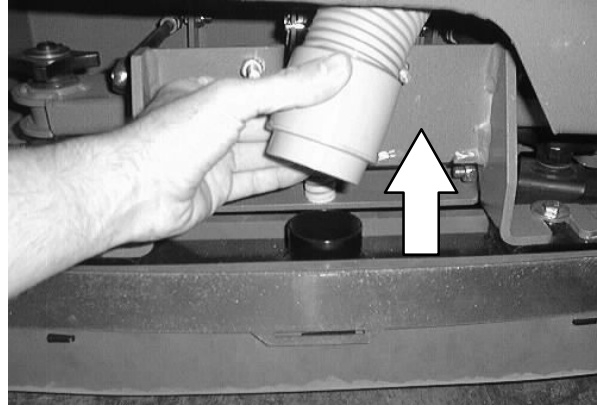

5. Connect the vacuum wand hose and the squeegee suction hose with the adapter.

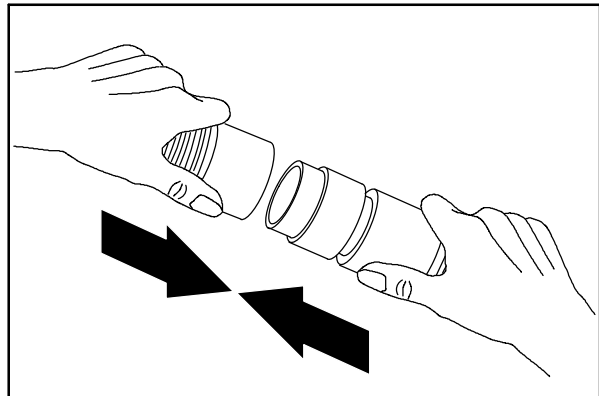

10945

6. Attach the end of solution hose to the quick-disconnect. Push the connector in until it stops. Pull on the hose to make sure it is connected.

7. Attach the other ends of the solution and vacuum hoses to the power wand.

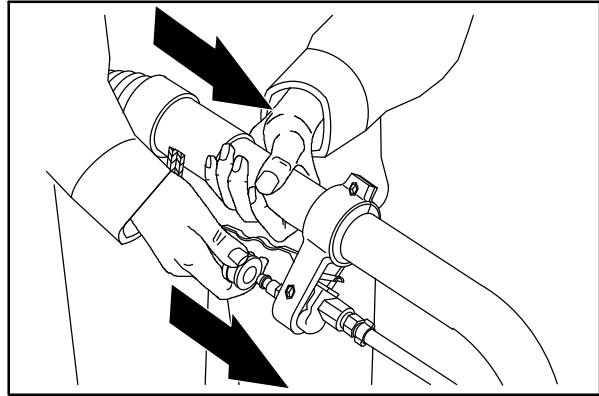

07320

8. Turn the machine power on.

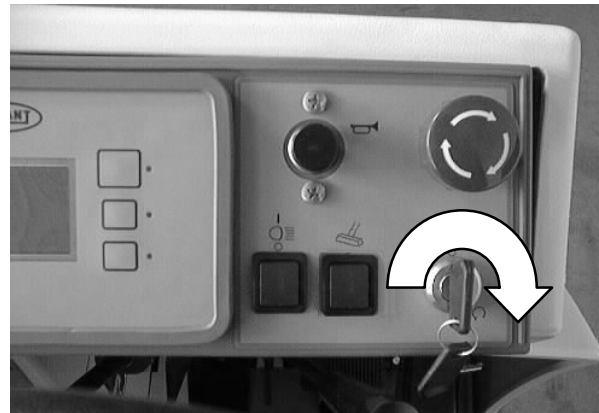

9. Press the rear squeegee switch to turn on the vacuum.

NOTE: The rear squeegee will also lower.

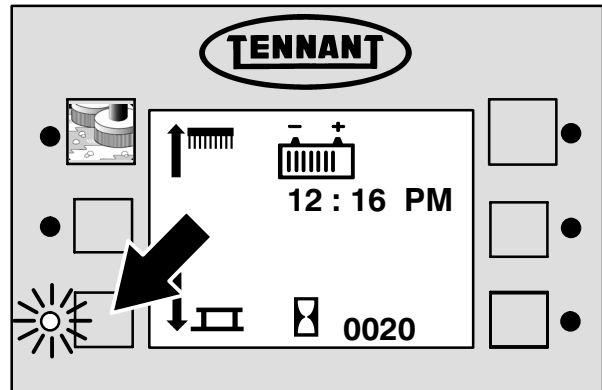

353565

OPERATION

10. Press the top of the power wand switch to turn the power wand on.

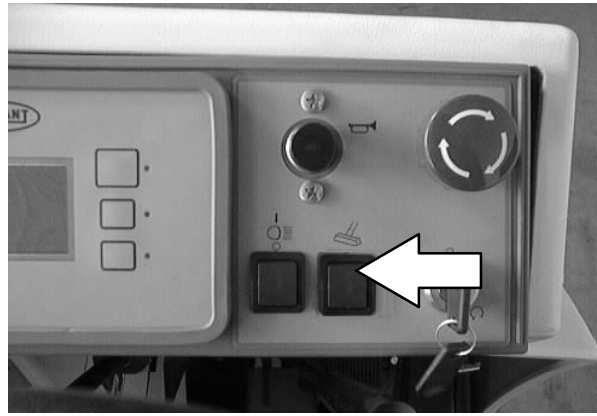

11. Squeeze the solution lever on the power wand to spray solution on the floor. Scrub the floor with the brush side of the cleaning tool.

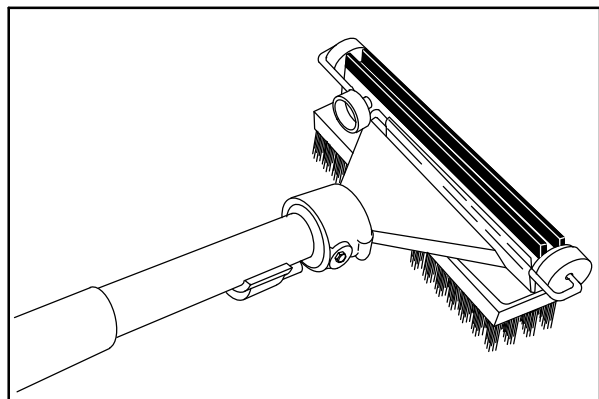

06601

12. Vacuum up the solution by turning over the cleaning tool so the squeegee side is down.

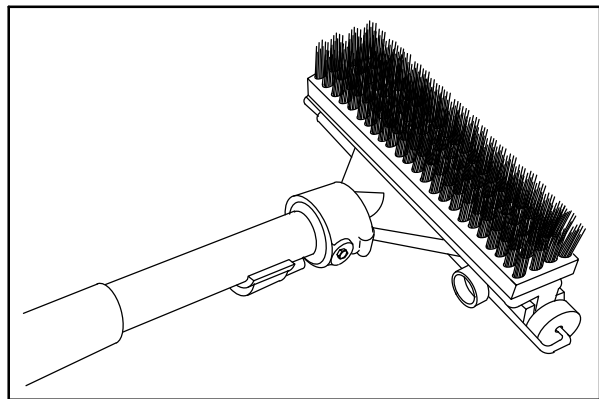

06202

If the cleaning tool is hard to push or is not picking up the solution very well, adjust the roller wheels on the tool by turning the black adjustment knob.

NOTE: The wheels are properly adjusted when the squeegee blades deflect slightly while the tool is pushed back and forth.

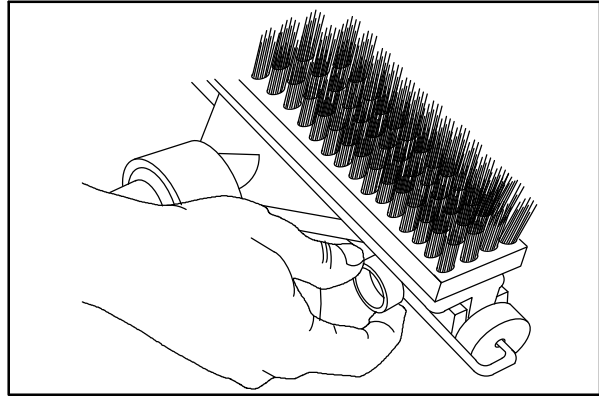

06604

13. When finished, press the bottom of the power wand switch to turn off the power wand.

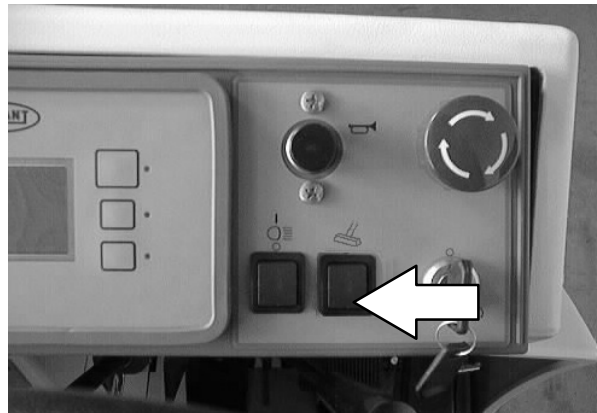

14. Press the rear squeegee switch to shut off the vacuum.

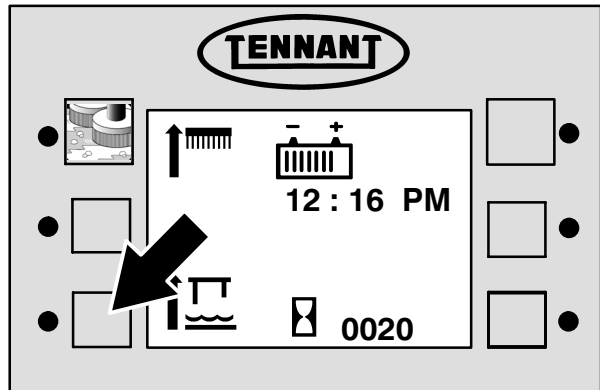

353550

OPERATION

15. Turn the machine power off.

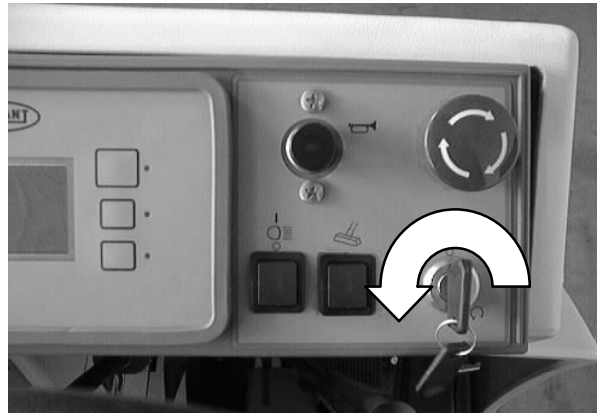

16. Disconnect the solution hose from the machine.

17. Remove the vacuum hose from the squeegee suction hose.

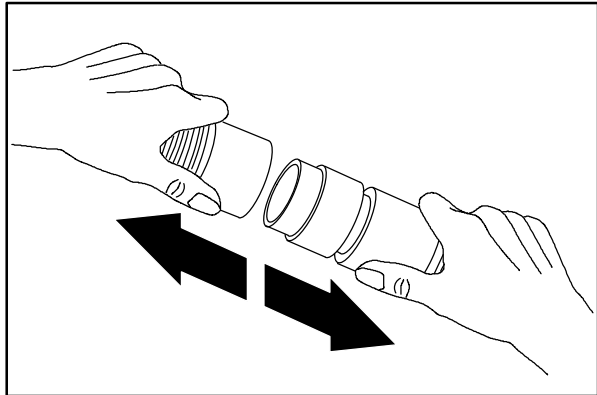

10946

18. Reconnect the squeegee suction hose to the squeegee.

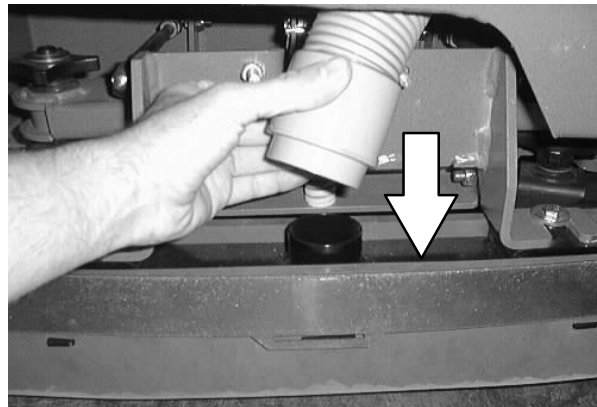

19. Disconnect the other ends of the solution and vacuum hoses from the power wand.

20. Secure the power wand equipment on top of the tank cover.

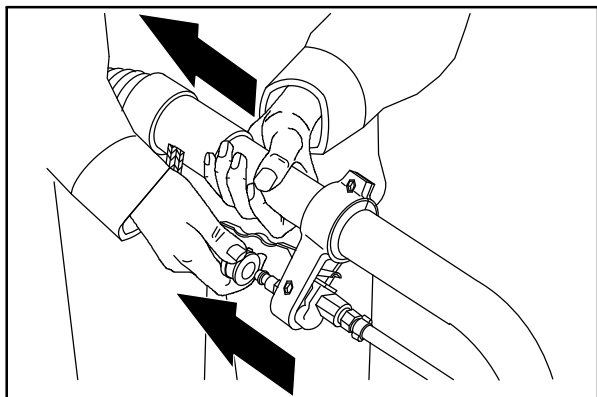

07321

MACHINE TROUBLESHOOTING

Problem	Cause	Remedy
Trailing water – poor or no water pickup.	Rear squeegee blades worn	Rotate or replace blades
	Rear squeegee out of adjustment	Adjust rear squeegee
	Rear squeegee raised	Lower rear squeegee
	Rear squeegee tube clogged	Flush squeegee tube
	Side squeegees raised	Lower side squeegees
	Side squeegee blades worn	Replace side squeegee blades
	Side squeegees out of adjustment	Adjust side squeegees
	Too much solution flow to floor	Reduce solution flow to floor
	Vacuum hose clogged	Flush vacuum hoses
	Recovery tank cover not seated	Reseat tank cover
	Recovery tank cover seal worn	Replace seal
	Recovery tank full.	Drain recovery tank
	Float stuck shutting off vacuum	Clean float
	Debris caught on rear squeegee	Remove debris
	Foam filling recovery tank	Empty recovery tank; use less or change detergent
Vacuum hose to rear squeegee disconnected or damaged	Reconnect or replace vacuum hose	
Vacuum fan will not turn on	Recovery tank full	Drain recovery tank
	Vacuum fan circuit breaker tripped	Reset circuit breaker
	Machine in reverse or neutral	Propel forward
	Vacuum fan failure	Contact Tennant service representative
Little or no solution flow to the floor.	Solution tank empty	Fill solution tank
	Solution flow lever off	Open solution flow lever
	Solution supply lines plugged	Flush solution supply lines
	ES switch off	Turn ES switch on
	Manual control valve closed	Open valve more
Brush pressure light blinks and changes to a lower pressure setting.	Brush pressure set to heavy for the application	Decrease brush pressure setting

OPERATION

Problem	Cause	Remedy
Poor scrubbing performance.	Debris caught on scrub brushes	Remove debris
	Improper detergent or brushes used	Check with TENNANT representative for advice
	Scrub brush pressure not set properly	Replace scrub brushes
	Worn scrub brushes	Replace scrub brushes
Poor debris pick up with cylindrical brushes.	One or both brushes installed with herringbone pattern wrong	Correct cylindrical brush configuration
ES system does not fill solution tank.	Clogged solution pump or lines	Flush ES system
	ES float switch(es) stuck	Clean switch floats of debris
	Clogged ES pump filter	Clean ES filter
	Water levels too low in tanks	Add water to tanks
Poor sweeping performance.	Brush bristles worn.	Replace brushes
	Sweeping brushes not properly adjusted.	Adjust brushes.
	Brush drive failure.	Contact Tennant service representative
FaST System does not operate	FaST switch is set for Conventional scrubbing	Set the FaST switch for FaST system scrubbing
	FaST circuit breaker tripped	Determine cause and reset the 10A circuit breaker button
	Clogged FaST PAK supply hose and/or connector	Soak connector and hose in warm water and clean
	FaST PAK carton is empty or not connected	Replace FaST PAK carton and/or connect supply hose
	FaST system is not primed	Prime the FaST system
	Clogged flow control orifice/screen	Remove and clean orifice/screen
	Faulty pump or air compressor	Contact TENNANT representative
	Clogged filter screen	Drain solution tank, remove and clean filter screen
	Faulty detergent timer module	Contact Tennant representative
ec-H2O Model: ec-H2O system indicator light blinking red	Mineral deposit build-up in module	Flush module (See <i>ec-H2O</i> MODULE FLUSH PROCEDURE)
ec-H2O Model: Alarm sounds		
ec-H2O Model: ec-H2O system indicator light solid red	Defective module	Contact Service Center
ec-H2O Model: ec-H2O system indicator light does not turn on	Defective light or module	Contact Service Center
ec-H2O Model: No water flow	Clogged module	Contact Service Center
	Defective solution pump	Replace solution pump

MAINTENANCE

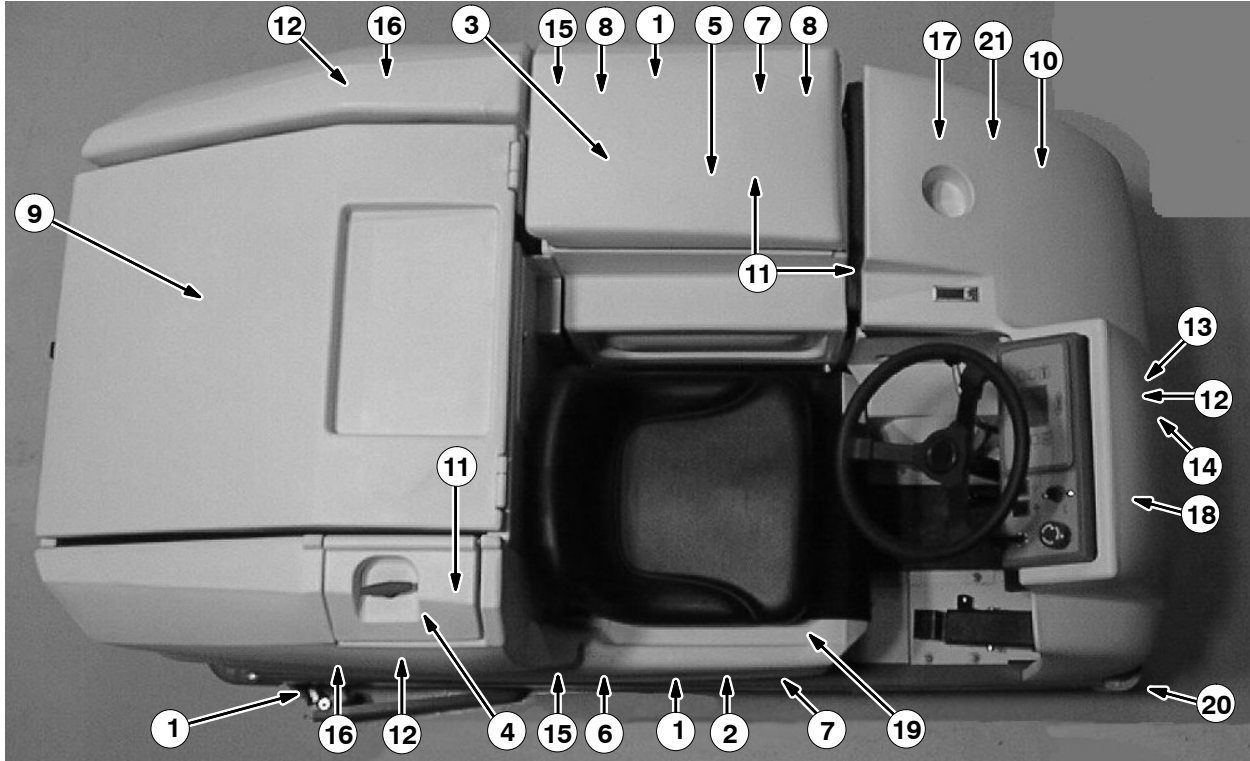

MAINTENANCE CHART

NOTE: Check procedures indicated (■) after the first 50-hours of operation.

Interval	Key	Description	Procedure	Lubricant/ Fluid	No. of Service Points
Daily	1	Rear and side squeegees	Check for damage, wear and adjustment	-	3
				-	1
	2	Scrub brushes	Check for damage and wear	-	2
			Check for debris	-	2
	20	Side brush(es) (option)	Check for damage and wear	-	1, 2
			Check for debris	-	1, 2
	3	Recovery tank	Clean	-	1
	3	Recovery tank, ES mode	Clean ES filter	-	1
	4	Solution tank, ES mode	Clean and flush	-	1
	5	Vacuum fan filter	Clean and flush	-	1
	6	Debris trough (Cylindrical brushes only)	Check and clean	-	1
	21	FaST PAK supply hose and connector	Clean and connect hose to storing plug when not in use	-	1
-	Machine	Check for leaks	-	1	

MAINTENANCE

Interval	Key	Description	Procedure	Lubricant/ Fluid	No. of Service Points
50 Hours	7	Cylindrical brushes	Check Taper	–	2
			Rotate front to rear	–	2
	8	Scrub head floor skirts (Disk brush heads only)	Check for damage and wear	–	1
	9	Battery cells	Check electrolyte level	DW	1
100 Hours	21	FaST Filter screen	Clean	–	1
	16	Brakes	Check adjustment	–	1
	7	Cylindrical scrub brush drive belts	Check for damage and wear	–	1
	11	Front and tank cover seals	Check for damage and wear	–	1
	10	Hydraulic fluid (opt.)	Check fluid level	HYDO	1
	12	Front wheel support bearing	Lubricate	SPL	2
	13	Propelling gearbox	Check lubricant level	GL	1
	15	Scrub head drag link arm pivot points (S/N 000000–003695)	Lubricate	SPL	8(4)
200 Hours	12	Tires	Check for damage and wear	–	3
	21	FaST Air filter (S/N 000000–003746)	Clean	–	1
500 Hours	17	Vacuum fan motors	Check motor brushes	–	2
	12	Front wheel	■ Torque wheel nuts	–	1
	12	Rear wheel bearings	Check, lubricate, and adjust	SPL	1
	15	Scrub head gas spring	Check for wear and operation	–	1
	18	Steering gear chain	■ Check tension and lubricate	GL	1
	10	Hydraulic hoses (opt.)	Check for damage and wear	–	1
1000 Hours	13	Propelling gearbox	■ Change fill-level plug seals	–	1
			■ Change gear lubricant	GL	1
	19	Scrubbing brush drive motors	Check motor brushes	–	2,3
	13	Propelling motor	Check motor brushes	–	1
	20	Side brush motor (opt.)	Check motor brushes	–	1, 2
21	FaST injector filters (S/N 003747–)	Replace	–	2	
1200 Hours	10	Hydraulic fluid filter (opt.)	* Change filter element	–	All
2400 Hours	10	Hydraulic fluid reservoir (opt.)	* Change hydraulic fluid	HYDO	1

NOTE: Change the hydraulic fluid, filter, and suction strainer, indicated (), after every 800 hours for machines NOT originally equipped with **TennantTrue** premium hydraulic fluid. (See Hydraulics section).*

SPL – Special lubricant, Lubriplate EMB grease (Tennant part no. 01433–1)

GL – SAE 90 weight gear lubricant

HYDO – **TennantTrue** premium hydraulic fluid or equivalent

DW – Distilled water

LUBRICATION

PROPELLING GEARBOX

Check the lubricant level in the propelling gearbox every 100 hours of operation. Change the gear lubricant, and the drain and fill-level plug seals after the first 50 hours of operation, and then every 1000 hours of operation. Use SAE 90 weight gear lubricant.

FOR SAFETY: When servicing machine, block machine tires before jacking machine up.

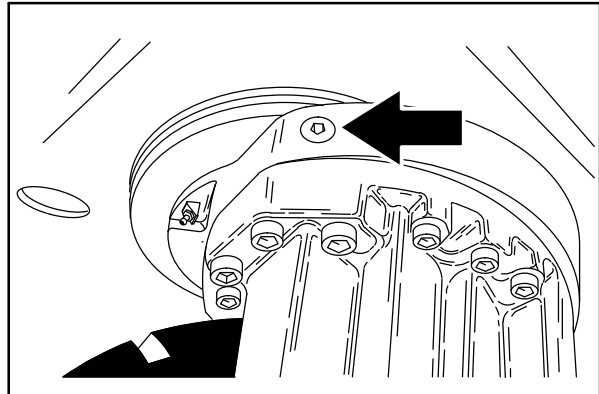

05934

FRONT WHEEL SUPPORT BEARING

The front wheel support has two grease fittings for the bearing. Raise the machine so the front wheel is off the floor. Fill one of the grease fittings while rotating the gearbox from stop to stop. Fill the second grease fitting while rotating the gearbox back to the original position. The bearing cavity is full when grease comes out of the fittings, or out of the top seal.

Lubricate with Lubriplate EMB grease (Tennant part no. 01433-1) every 100 hours of machine operation, or after steam cleaning the gearbox area.

FOR SAFETY: When servicing machine, use hoist or jack that will support the weight of the machine.

FOR SAFETY: When servicing machine, jack machine up at designated locations only. Block machine up with jack stands.

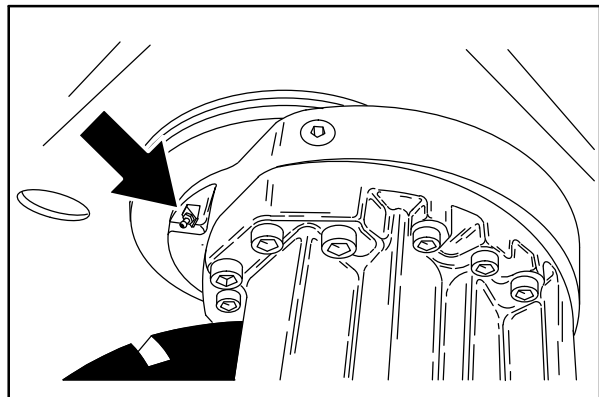

05934

MAINTENANCE

SCRUB HEAD DRAG LINK ARMS (S/N 000000-003695)

The scrub head drag link arms have a grease fitting at each of the pivot points. Lubricate with Lubriplate EMB grease (Tennant Part No. 01433-1) every 100 hours of operation.

The MaxPro 1000 disk scrub head has four link arms that need lubrication.

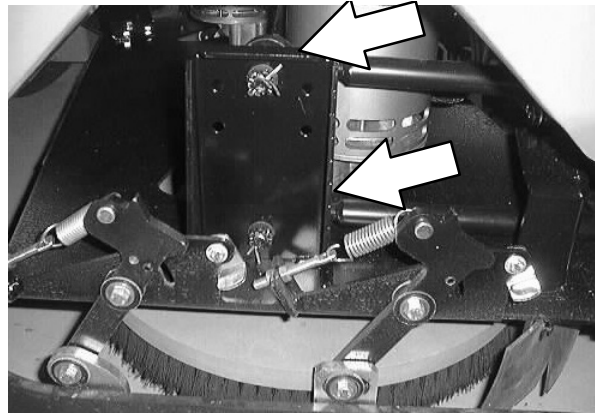
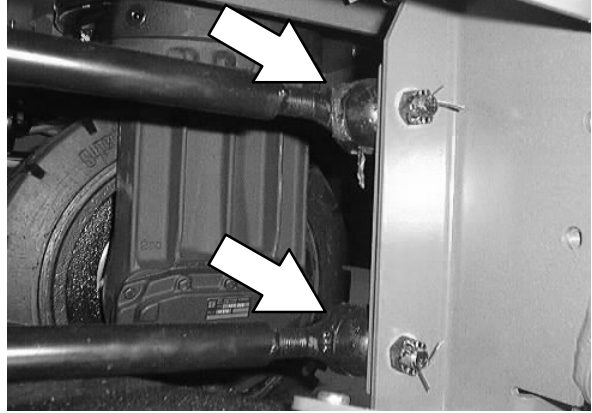

The Maxpro 1200 disk scrub head has two link arms that need lubrication.

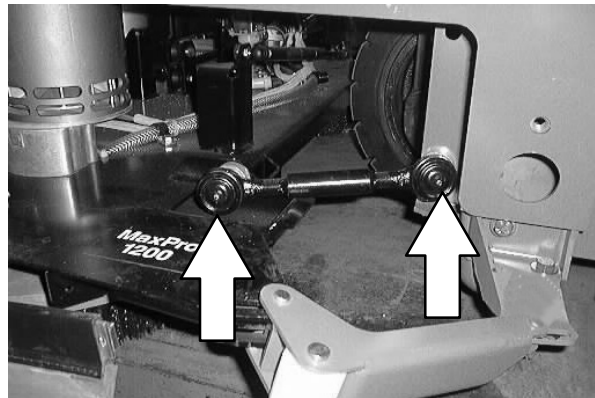

The Maxpro 1000 and the Maxpro 1200 cylindrical scrub heads each have two arms that need lubrication.

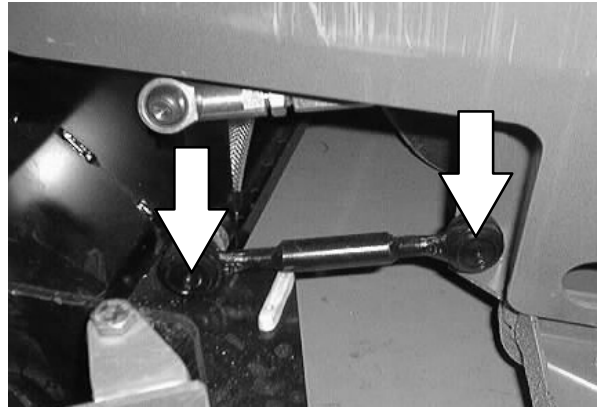

REAR WHEEL BEARINGS

Inspect the rear wheel bearings for seal damage, and repack and adjust every 500 hours of operation. Use Lubriplate EMB grease (Tennant part number 01433-1).

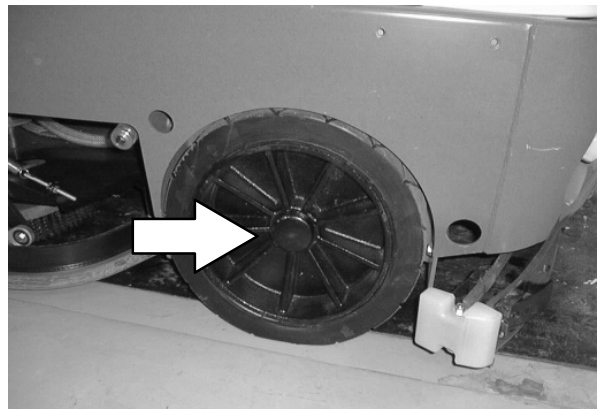

STEERING GEAR CHAIN

The steering gear chain is located by the foot pedals. Lubricate the chain with SAE 90 weight gear lubricant after the first 50, and then after every 500 hours of operation.

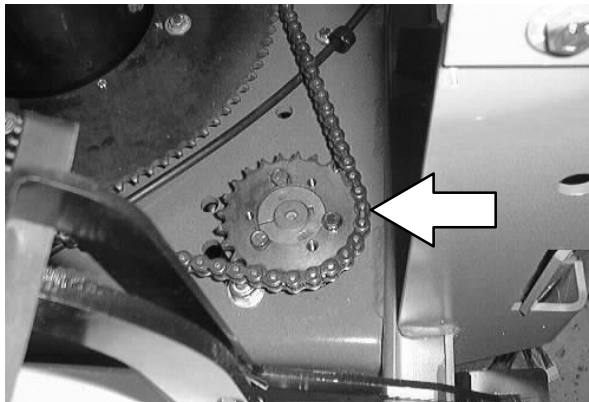

HYDRAULICS (OPTION)

HYDRAULIC FLUID RESERVOIR

The hydraulic reservoir holds the hydraulic fluid for the power steering option. It is located underneath the front cover of the machine. A filler cap is mounted on top of the reservoir.

Check the hydraulic fluid level at operating temperature after every 100 hours of operation. The reservoir should be filled to 2" +/- .5" below the top of the reservoir. The top of the spring assembly that holds down the filter inside the reservoir can be used as a gauge.

Lubricate the filler cap gasket with a film of hydraulic fluid before putting the cap back on the reservoir.

ATTENTION! Do not overfill the hydraulic fluid reservoir or operate the machine with a low level of hydraulic fluid in the reservoir. Damage to the machine hydraulic system may result.

Drain and refill the hydraulic fluid reservoir with new **TennantTrue** premium hydraulic fluid after every 2400 hours of operation. Machines have a blue colored drop (left photo) on the hydraulic fluid label if originally equipped with **TennantTrue** premium hydraulic fluid.

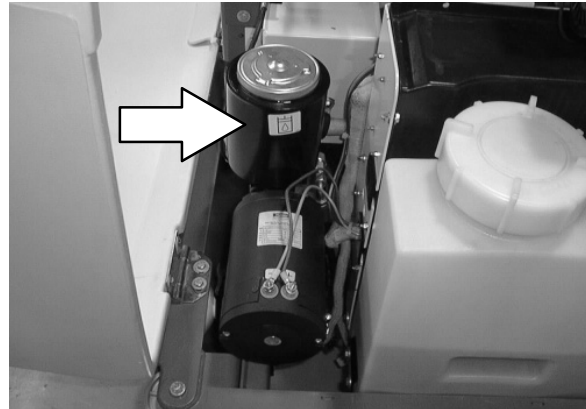

TennantTrue Fluid



Previous Fluid

*NOTE: Change the hydraulic fluid, filter, and suction strainer after every 800 hours for ALL machines that have NOT consistently used **TennantTrue** premium hydraulic fluid or equivalent.*

The reservoir has a built-in filter outlet that filters hydraulic fluid before it enters the system. Replace the filter every 1200 hours of operation.

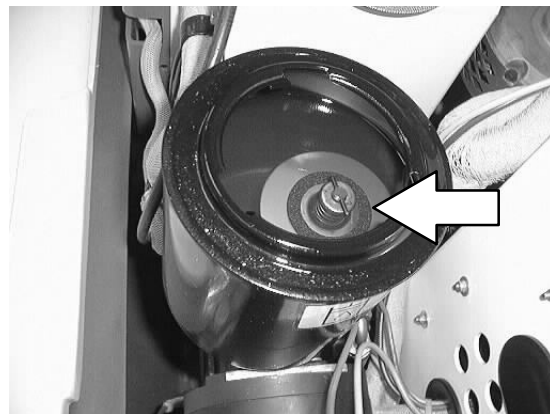

HYDRAULIC FLUID

TennantTrue premium hydraulic fluid (Extended Life)		
Part number	ISO Grade	Capacity
1057707	32	3.8 L (1 gal)
1057708	32	19 L (5 gal)

If using a locally-available hydraulic fluid, be sure the specifications match the Tennant hydraulic fluid specifications. Substitute fluids can cause premature failure of hydraulic components.

ATTENTION! Hydraulic components depend on system hydraulic fluid for internal lubrication. Malfunctions, accelerated wear, and damage will result if dirt or other contaminants enter the hydraulic system.

HYDRAULIC HOSES

Check the hydraulic hoses after every 500 hours of operation for wear or damage.

Fluid escaping at high pressure from a very small hole can be almost invisible, and can cause serious injuries.

See a doctor at once if injury results from escaping hydraulic fluid. Serious infection or reaction can develop if proper medical treatment is not given immediately.

FOR SAFETY: When servicing machine, use cardboard to locate leaking hydraulic fluid under pressure.

If you discover a fluid leak, contact your mechanic or supervisor.

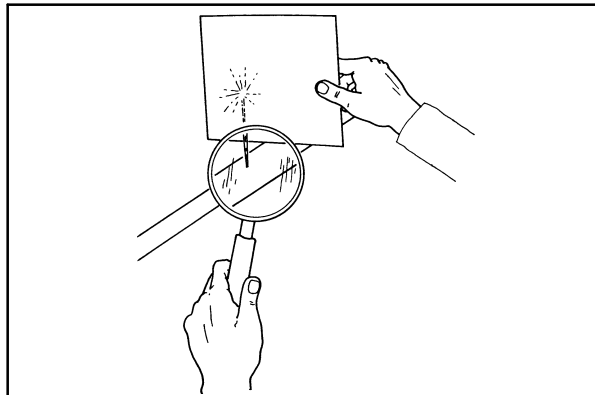

00002

BATTERIES

The batteries are unique in that they hold their power for long periods of time. The lifetime of the batteries is limited by the number of charges the batteries receive. To get the most life from the batteries, charge them when all the battery discharge indicator segments shut off (20% charge left). Use an automatic charger with the proper rating for the batteries.

Periodically clean the top surface of the batteries and terminals with a strong solution of baking soda and water. Brush the solution sparingly over the battery tops, terminals, and cable clamps. Do not allow any baking soda solution to enter the batteries. Use a wire brush to clean the terminal posts and the cable connectors. After cleaning, apply a coating of clear battery post protectant to the terminals and the cable connectors. Check the batteries for loose connections. Keep the tops of the batteries clean and dry.

Keep all metallic objects off the top of the batteries, which may cause a short circuit. Replace any worn or damaged wires.

Check the electrolyte level in each battery cell before and after charging, and after every 50 hours of operation. Do not charge the batteries unless the fluid is slightly above the battery plates. If needed, add just enough distilled water to cover the plates. Never add acid to the batteries. Do not overfill. Always keep the battery caps on, except when adding water or taking hydrometer readings.

Measuring the specific gravity, using a hydrometer, is a way to determine the charge level and condition of the batteries. If one or more of the battery cells test lower than the other battery cells (0.050 or more), the cell is damaged, shorted, or is about to fail.

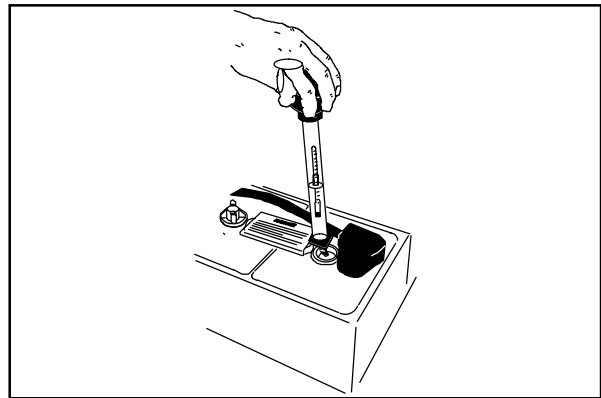
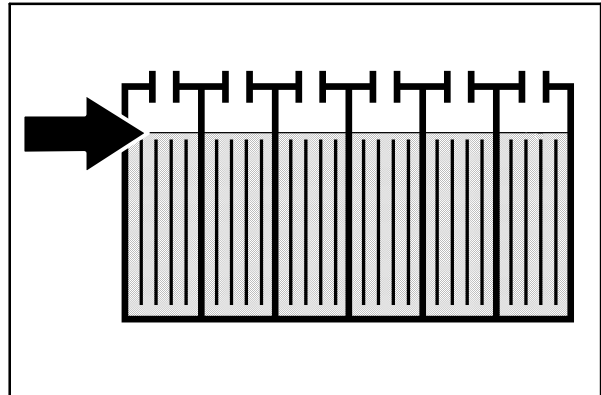
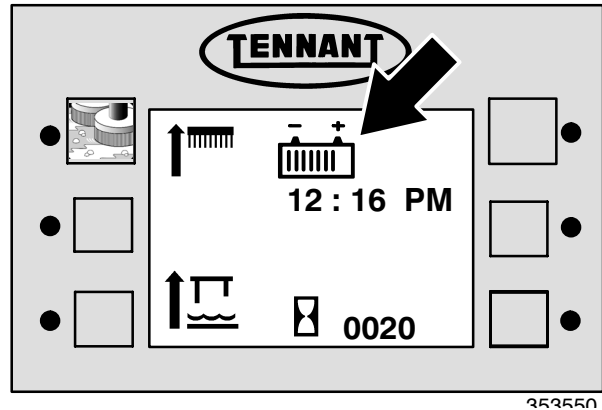

04380

NOTE: Do not take readings immediately after adding distilled water. If the water and acid are not thoroughly mixed, the readings may not be accurate. Check the hydrometer readings against the following chart to determine the remaining battery charge level:

SPECIFIC GRAVITY at 27° C (80° F)	BATTERY CHARGE
1.290	100% Charged
1.252	75% Charged
1.200	50% Charged
1.177	25% Charged
1.140	Discharged

NOTE: If the readings are taken when the battery electrolyte is any temperature other than 27° C (80° F), the reading must be temperature corrected. Add or subtract to the specific gravity reading 0.004, 4 points, for each 6° C(10° F) above or below 27°C(80° F).

NOTE: For machines with the rollout battery option, remove the cable tie before removing batteries.

CHARGING THE BATTERIES

1. Drive the machine to a flat, dry surface in a well-ventilated area.
2. Turn the machine power off and set the parking brake.

FOR SAFETY: Before leaving or servicing machine; stop on level surface, turn off machine.

3. Open the top battery compartment cover. The support arm will engage when the cover is lifted all the way up.

⚠ WARNING: Batteries emit hydrogen gas. Explosion or fire can result. Keep sparks and open flame away. Keep covers open when charging.

4. Open the rear battery compartment door.

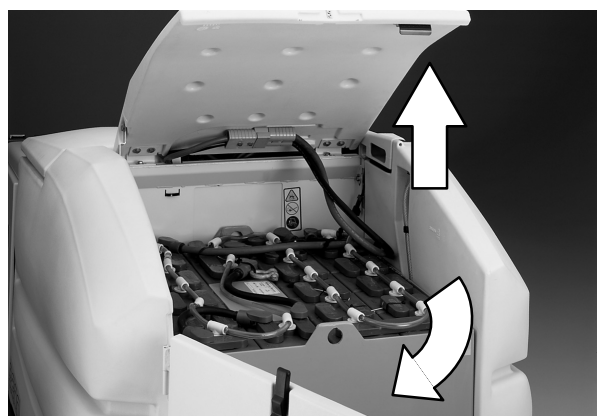
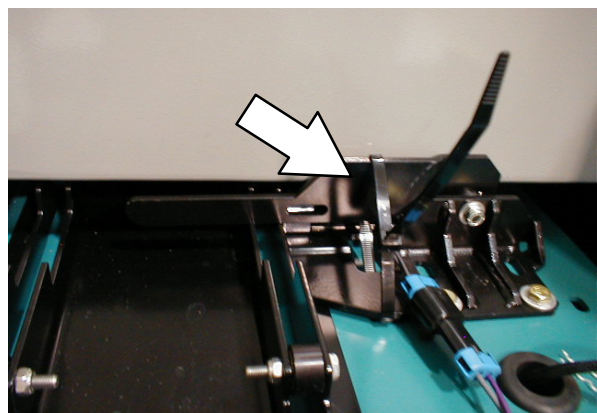

MAINTENANCE

- Check the electrolyte level in all the battery cells.

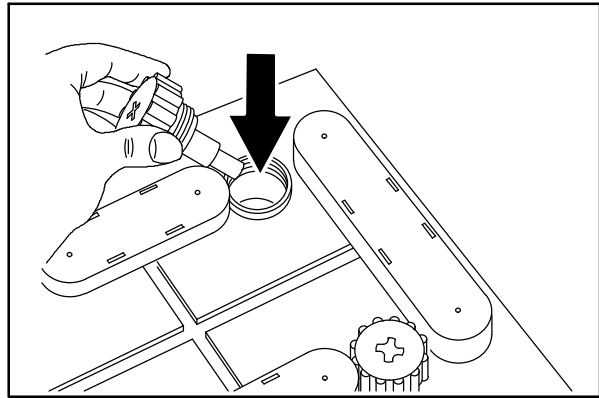

08247

- If the level is low, add just enough distilled water to cover the plates. **DO NOT OVERFILL.** The batteries can overflow during charging due to expansion.

NOTE: Make sure the battery caps are in place while charging.

FOR SAFETY: When maintaining or servicing machine, avoid contact with battery acid.

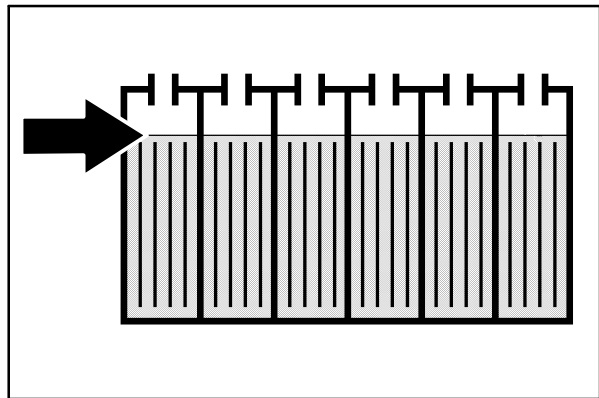

- Unplug the battery connector from the machine connector.
- Plug the charger connector into the battery connector.
- Plug the battery charger into the wall outlet.

NOTE: If the red "ABNORMAL CYCLE" lamp lights when the TENNANT charger is plugged into a wall outlet, the charger can not charge the battery and there is something wrong with the battery.

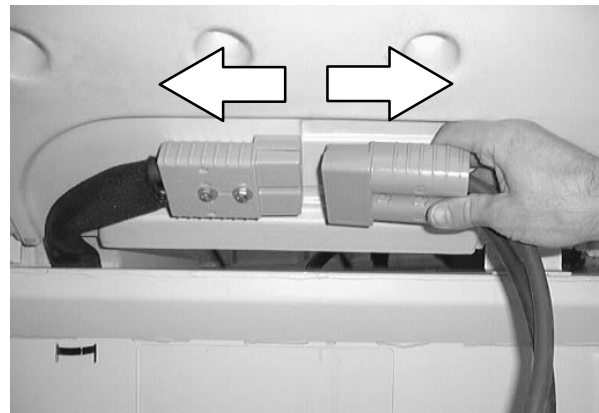

- The Tennant charger will start automatically. When the batteries are fully charged, the Tennant charger will automatically turn off.

NOTE: Use a charger with the proper rating for the batteries to prevent damage to the batteries or reduce the battery life.

NOTE: If the charger needs to be disconnected from the machine before the batteries are fully charged and the charger has not automatically shut off, turn off the charger before disconnecting it.

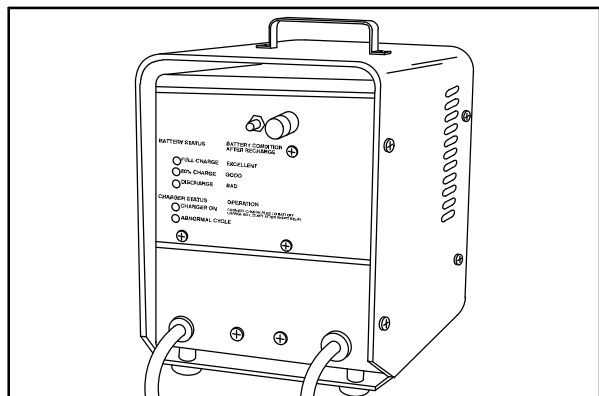

07224

11. After the charger has turned off, unplug the charger from the wall outlet.
12. Unplug the charger connector from the battery connector on the machine.
13. Reconnect the battery connector to the machine connector.
14. Check the electrolyte level in each battery cell after charging. If needed, add distilled water to raise the electrolyte level to about 12mm (0.4 in) below the bottom of the sight tubes.

FOR SAFETY: When maintaining or servicing machine, avoid contact with battery acid.

15. Close the rear battery compartment door. Disengage the support arm, and close the top battery compartment cover.

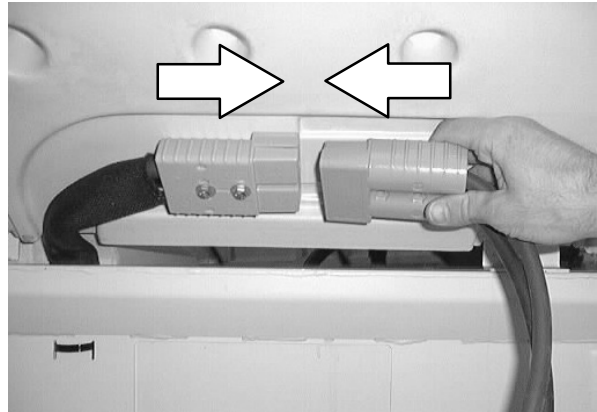

CONTROL PANEL

The control panel can be used to run a self-diagnostic test of the machine electrical components and system. When the self-diagnostic test is running, motors and actuators on the machine will activate.

FOR SAFETY: When servicing machine, avoid moving parts. Do not wear loose jackets, shirts, or sleeves.

1. Turn the machine off.
2. Press and hold the logo switch.
3. Turn the machine power on.
4. Continue pressing the logo switch for 15 seconds or until the down pressure display screen appears.
5. Press and release the TENNANT logo button two more times. The SELF TEST screen will appear on the display.

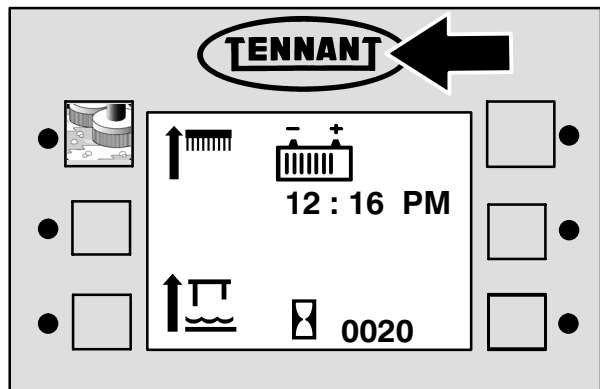

353550

MAINTENANCE

- Press the switch next to SELF TEST.
- While the diagnostic is running, the machine systems will activate as follows:

- The brushes and squeegee raise.
- The rear squeegee lowers and then raises back up.
- The scrub head lowers and moves out to the edge scrub position. The scrub head moves back in again and raises.
- The brushes turn on and off.
- The solution tank auto-fill valve (option) turns on and off.
- The ES pump turns on and off, if the machine has the ES option.
- If the machine has FaST / *ec-H2O*, the FaST / *ec-H2O* system turns on and off.
- The vacuum fan relay is momentarily energized (the vacuum fan does not turn on).
- The brushes turn on and off.
- The recovery tank auto-fill valve (option) turns on and off.

- If the electrical system passes the self-diagnostic test, an OK message will appear on the control panel display.

If the self-diagnostic test finds an error in the system, an error message will appear on the control panel display. Note the error message displayed, and contact the service personnel.

- Turn off the diagnostic by turning off the machine power.

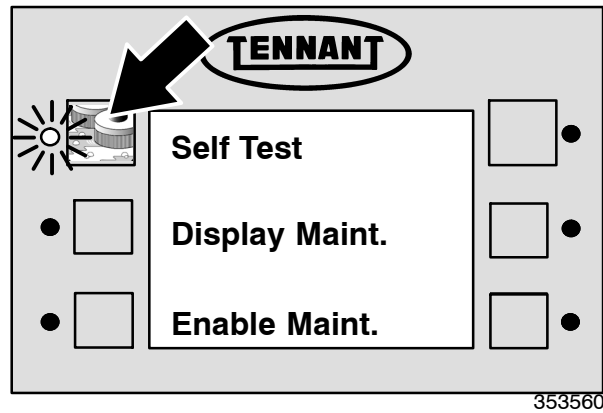

353560

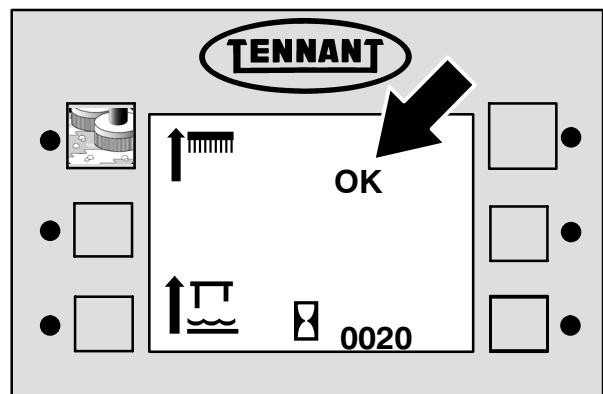

353561

ELECTRIC MOTORS

The carbon brushes on the vacuum fan motors should be inspected every 500 hours of machine operation. The brush drive motors and propelling motor should be inspected every 1000 hours of operation.

PROPELLING CIRCUIT

The propelling circuit is a transistorized controller. It controls the forward and reverse speed of the machine and is located in the controller panel. The circuit cannot be serviced by the user – only trained personnel should be allowed to work on it. Do not steam clean or spray the panel with water because the electrical system may be damaged.

NOTE: A static discharge grounding strap should be used when servicing the electronic circuitry.

SCRUB HEAD

The machine can be equipped with either disk or cylindrical heads. There are two scrub head widths available for each type of scrub head. The scrub head floor skirts control water spray from the brushes.

The MaxPro 1000 disk scrub head contains two disk scrub brushes, and is available with standard or heavy duty scrubbing motors.

The MaxPro 1000 disc head has a 1020 mm (40 in) scrubbing path.

The MaxPro 1200 disc head has three disks, and a 1220 mm (48 in) path.

The MaxPro 1000 cylindrical head has a 1020 mm (40 in) scrubbing path, and the MaxPro 1200 cylindrical head has a 1220 mm (48 in) path.

SCRUB HEAD GAS SPRING

Check the scrub head gas spring for wear and proper operation every 500 hours of operation.

SCRUB HEAD ADJUSTMENTS

The cylindrical scrub head is factory adjusted, and the measurements should not be changed unless scrub head parts are damaged or are replaced.

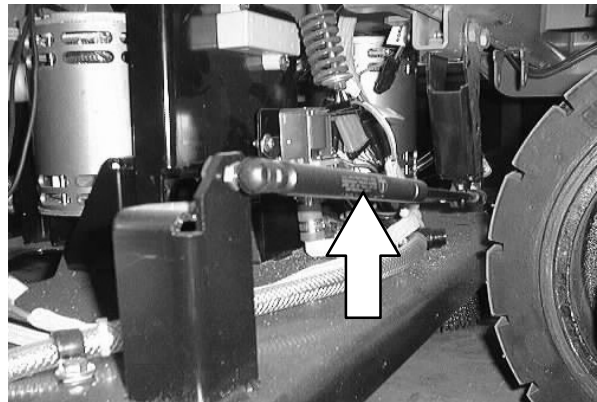

SCRUB BRUSHES

The machine can be equipped with either *disk* or *cylindrical* scrub brushes. Check scrub brushes daily for wire or string tangled around the brush or brush drive hub. Also check for brush damage and wear.

DISK BRUSHES

Replace the brushes when they no longer clean effectively.

NOTE: Replace worn brushes in sets. Scrubbing with brushes of unequal bristle length will result in diminished scrubbing performance.

REPLACING THE DISK BRUSHES

1. Raise the scrub head.
2. Turn the machine power off and set the parking brake.

FOR SAFETY: Before leaving or servicing machine, stop on level surface, set parking brake, turn off machine, and remove key.

3. Raise the side squeegee and lock in the up position using the side squeegee double scrub latches.

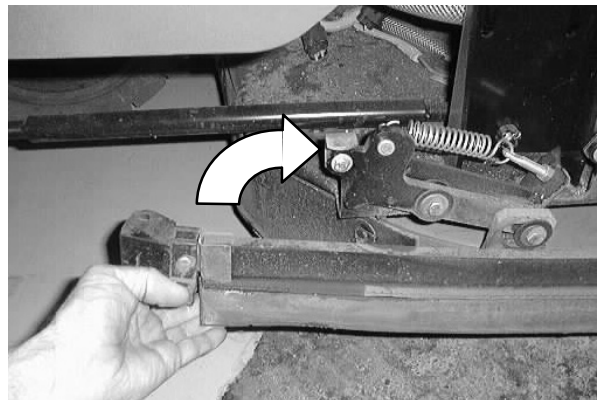

MAINTENANCE

4. Turn the brush until you can see the brush spring clip.

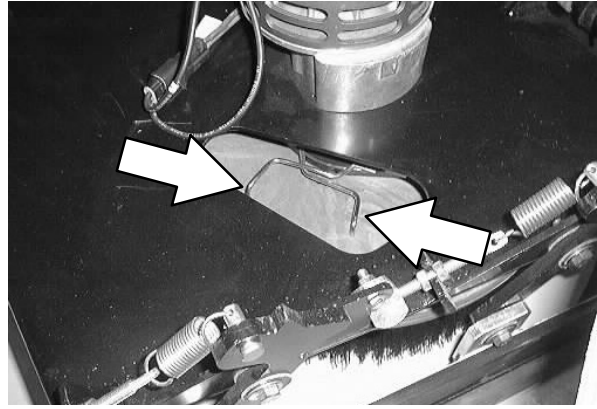

5. Squeeze the brush spring clips together with your thumb and index finger. The brush will drop off the brush drive hub. Pull the brush out from under the scrub head.

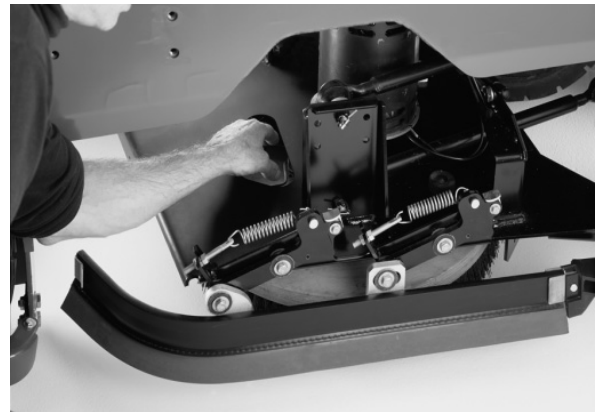

6. Place the new scrub brush on the floor in front of the scrub head. Push the brush under the scrub head.

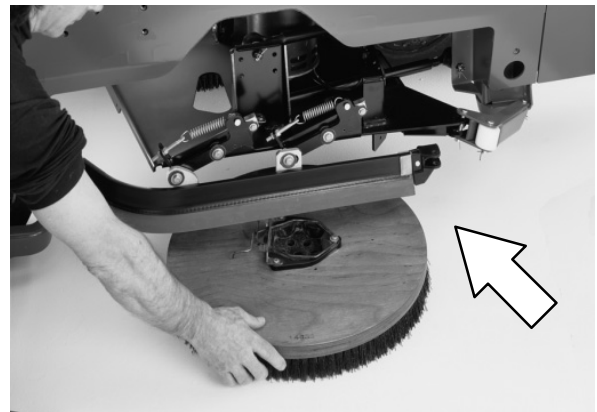

7. Line up the brush drive socket with the drive plug.
8. While squeezing the brush spring clip together with your thumb and index finger, lift the scrub brush onto the drive plug.
9. Check to make sure the brush is securely mounted on the brush drive hub.
10. Lift up on the side squeegee while releasing the side squeegee double scrub latches. Lower the side squeegee to the down position.



11. Repeat for the other brush.

CYLINDRICAL BRUSHES

Check the brush taper and rotate the brushes from front-to-rear every 50 hours of machine operation for maximum brush life and best scrubbing performance. Check and clean the cylindrical head debris trough daily.

Replace the brushes when they no longer clean effectively.

NOTE: Replace worn brushes in pairs. Scrubbing with brushes of unequal bristle length will result in diminished scrubbing performance.

NOTE: Fill the solution tank before checking or adjusting the brush pattern.

CHECKING AND ADJUSTING CYLINDRICAL BRUSH PATTERN

1. Apply chalk (or another material that will not easily blow away), to a smooth, level section of the floor.
2. Set the parking brake.

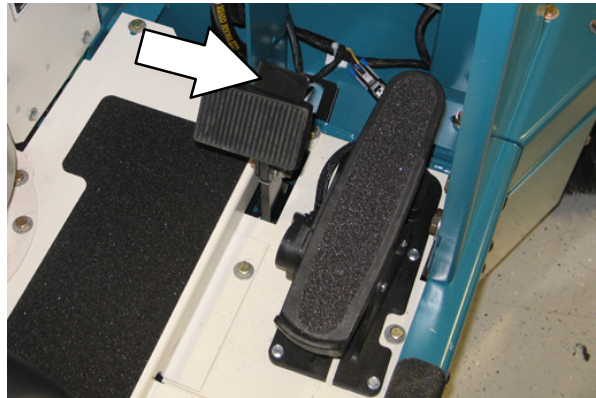

3. Lower the scrub head in the chalked area. Allow the machine to scrub in the same place for 15 to 20 seconds.

NOTE: If chalk or other material is not available, allow the brushes to spin on the floor for two minutes. A polish mark will remain on the floor.

4. Raise the scrub head and move the machine away from the chalked area. Turn the machine power off.

5. Observe the shape of the brush patterns. If the brush patterns have parallel sides, the brushes do not need adjustment.

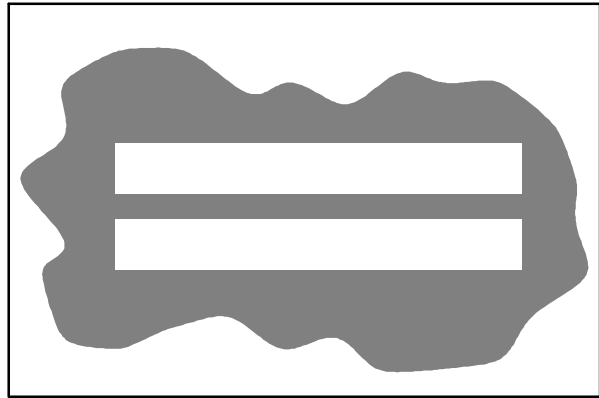

10355

If one, or both of the brush patterns are tapered, the brushes need adjustment to straighten the brush pattern.

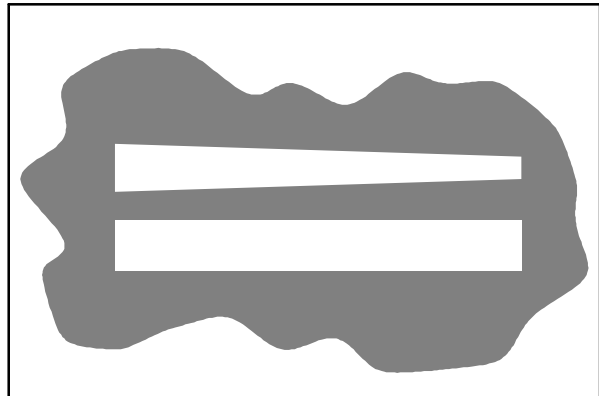

10356

- A. Open the side squeegee support door with the latch. Swing the support door outward to access the idler support cover.

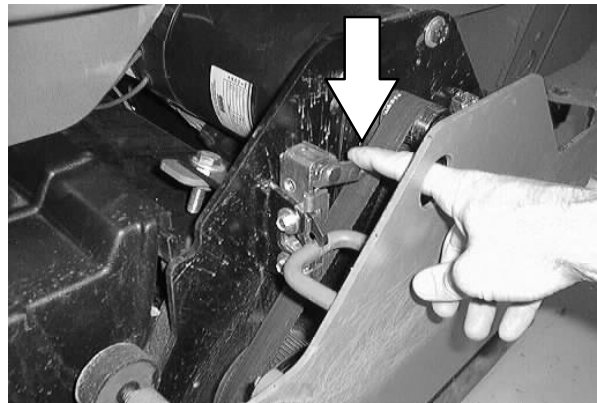

- B. Loosen the larger mounting screw on the outside of the idler door.

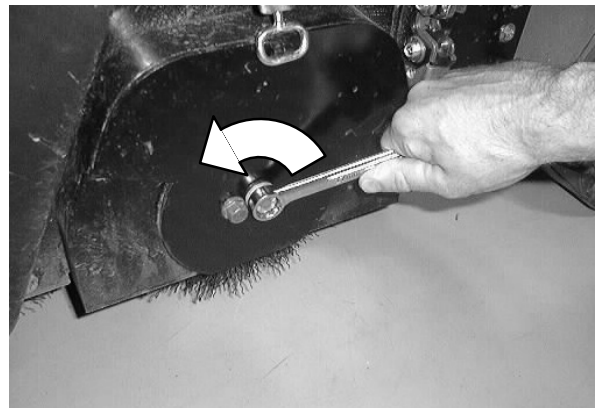

MAINTENANCE

- C. Raise or lower the end of the brush with the smaller brush adjustment screw as needed to straighten the brush pattern.
- D. Tighten the mounting screw to secure the brush.
- E. Close the side squeegee support door. Check the brush patterns again and readjust as necessary until both patterns are the same.

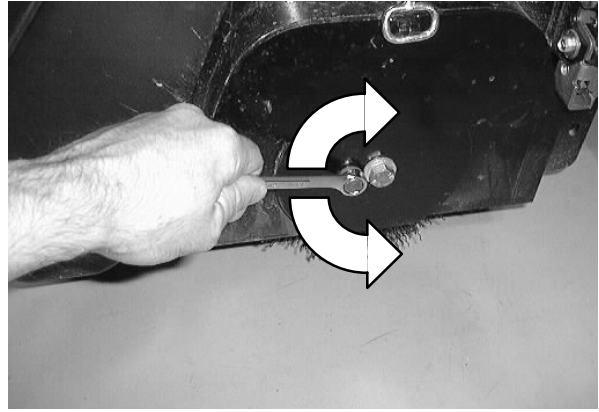

- 6. If one brush pattern is wider than the other, the scrub head needs to be leveled.

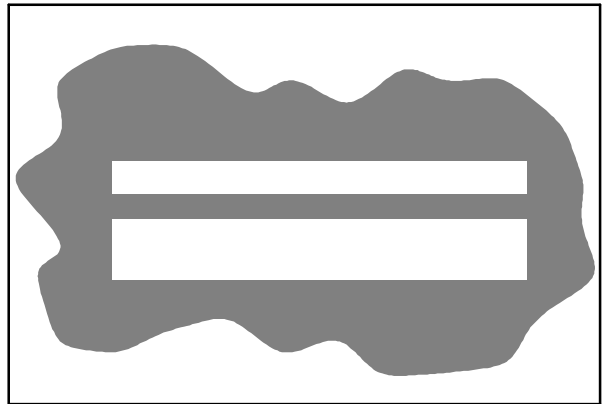

350630

Level the scrub head by turning the top scrub head drag link arm on both sides of the scrub head.

Check the brush patterns again and readjust as necessary until both patterns are the same.

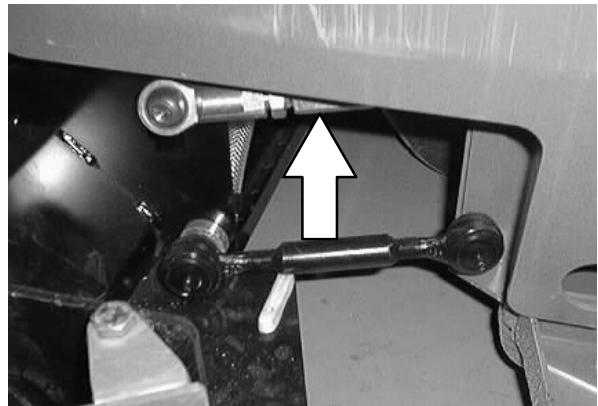

REPLACING THE CYLINDRICAL BRUSHES

1. Press the scrubbing switch. When the scrub head is approximately 25 mm (1 in) from the floor, turn the machine power off.
2. Set the parking brake.

FOR SAFETY: Before leaving or servicing machine, stop on level surface, set parking brake, turn off machine, and remove key.

3. Open the side squeegee support door with the latch. Swing the support door outward to access the idler support cover.

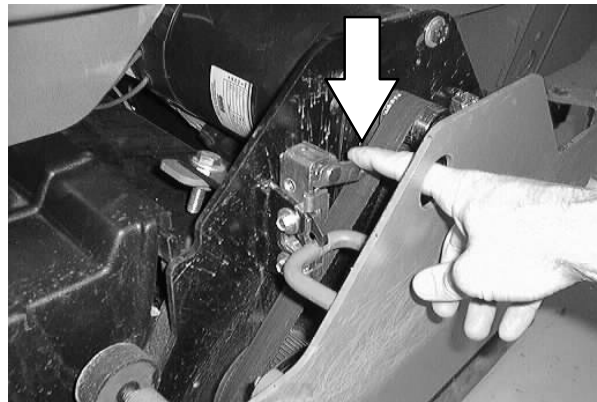

4. Lift up on the idler support latch to release the idler support cover.

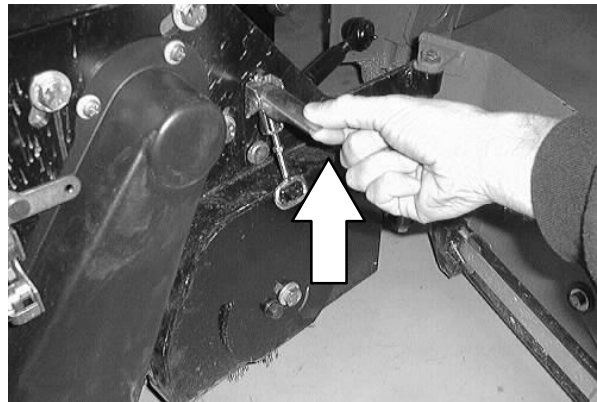

5. Pull the idler plug off the brush, and pull the old brush out of the scrub head.



MAINTENANCE

6. Position the brush with the *double row end towards you*. Guide the new brush onto the drive hub.
7. Insert the Idler plug (on the inside of the idler support cover), into the brush.

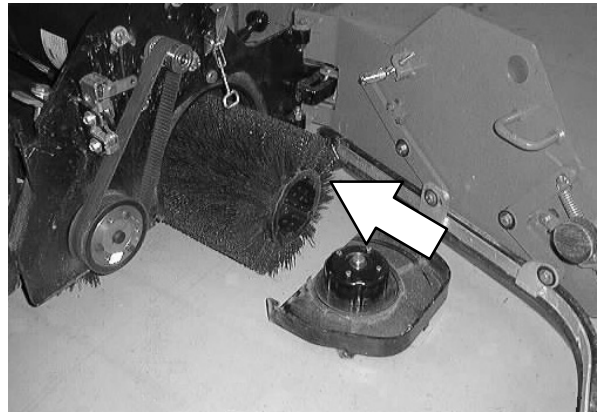

NOTE: Cylindrical scrub brushes must be installed with the herringbone patterns on the brushes pointing towards each other for best debris pick up.

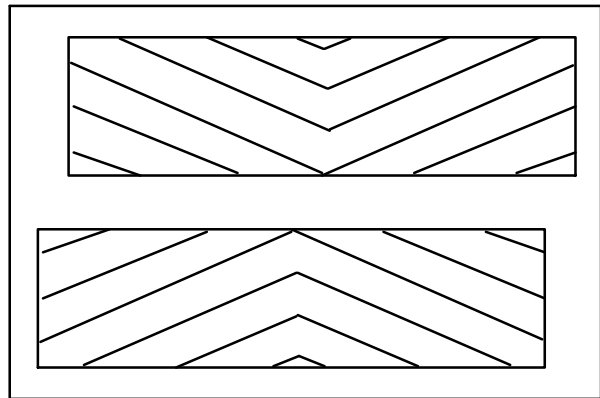

8. Secure the idler support cover with the idler support latch.

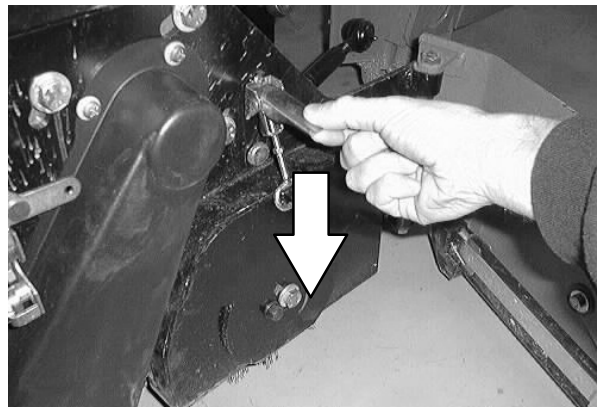

9. Firmly close the side squeegee support door. Check that the door bumper is tight against the debris tray.
10. Repeat for the other brush on the other side of the scrub head.

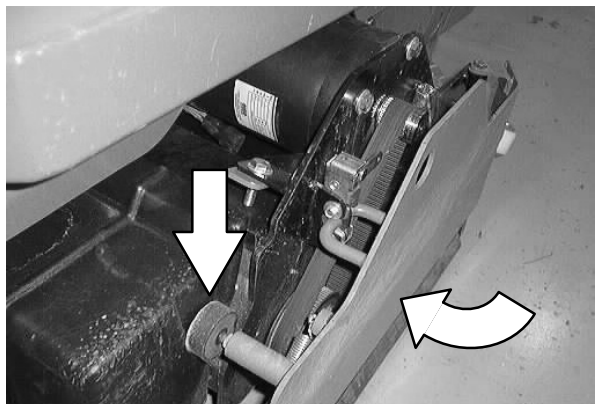

SIDE SWEEPING BRUSH (OPTION)

The side sweeping brush(es) sweep debris into the path of the cylindrical scrub brush. Check the side brush(es) daily for wear or damage. Remove any string or wire found tangled on the side brush(es) or side brush drive shafts.

The side sweeping brush(es) pattern should be checked periodically. The side brush bristles should contact the floor in a 10 o'clock to 3 o'clock pattern when the brush is in motion. The side brush pattern adjustment is made by turning the side brush adjustment knob.

Replace the brush(es) when they no longer clean effectively

REPLACING AND ADJUSTING THE SIDE SWEEPING BRUSH(ES)

1. Turn the machine power off and set the parking brake.

FOR SAFETY: Before leaving or servicing machine; stop on level surface, set parking brake, turn off machine and remove key.

2. Remove the retaining hardware mounting the side brush to the side brush drive shaft.
3. Slide the side brush off the side brush drive shaft.
4. Slide the new side brush onto the side brush drive shaft.
5. Mount the new side brush to the drive shaft with the mounting hardware.
6. Lower the hopper assembly
7. Check the side brush pattern. To increase the bristle contact with the floor, turn the side brush adjustment knob counter-clockwise. To decrease, turn the side brush adjustment knob clockwise.

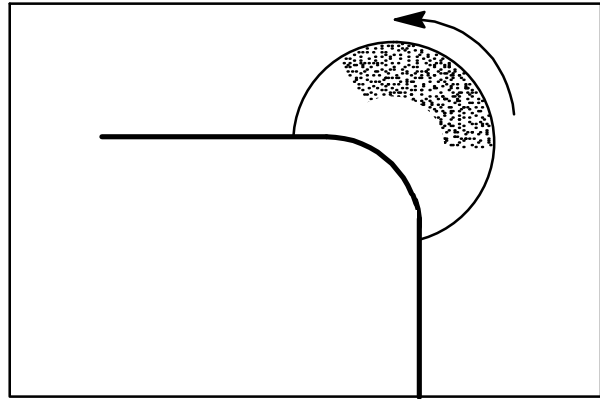

03376

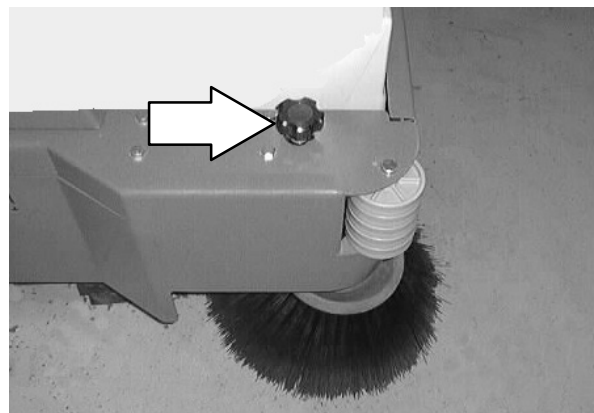

SOLUTION SYSTEM

SOLUTION VALVE

The solution valve controls the flow of solution to the scrub brushes. The valve linkage should provide the valve with fully open to fully closed positions.

The solution control cable can be adjusted at the solution lever or valve ends of the cable. To adjust the cable at the solution lever end, open the machine cover. To adjust the cable at the solution valve end of the cable, locate the valve by the scrub head. Adjust the cable with the valve in the off position.

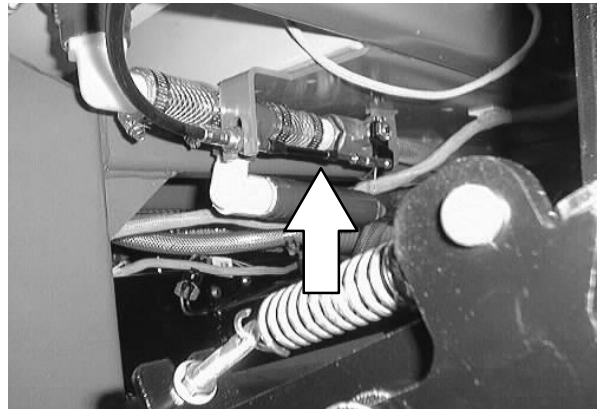

The solution lever has two mounting holes for the solution cable clevis. In the factory, the cable is mounted on the inside hole. The cable clevis can be moved to the outside hole for greater solution flow to the floor. This mounting position would be for rough floor conditions only.

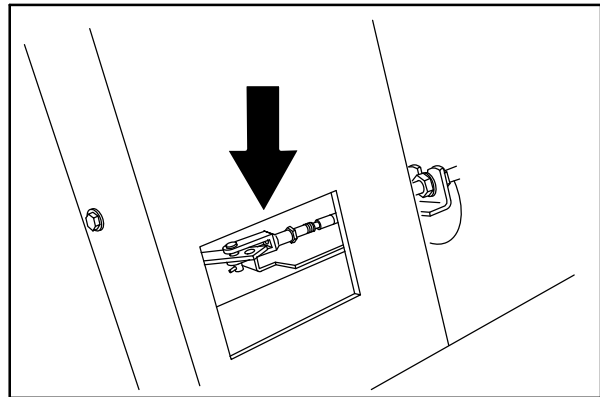

352716

RECOVERY TANK

The recovery tank stores recovered solution.

The recovery tank should be drained and cleaned daily, after the solution tank is empty, whenever the float stops the vacuum fan, or the recovery tank full indicator lights. See *DRAINING AND CLEANING THE TANKS* section of this manual.

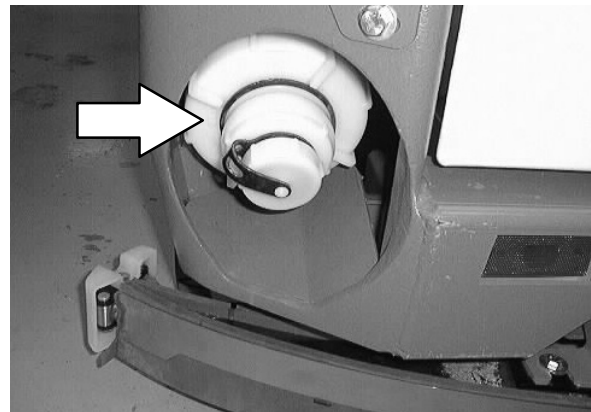

The vacuum fan filter should be cleaned daily. See *DRAINING AND CLEANING THE TANKS* section of this manual.

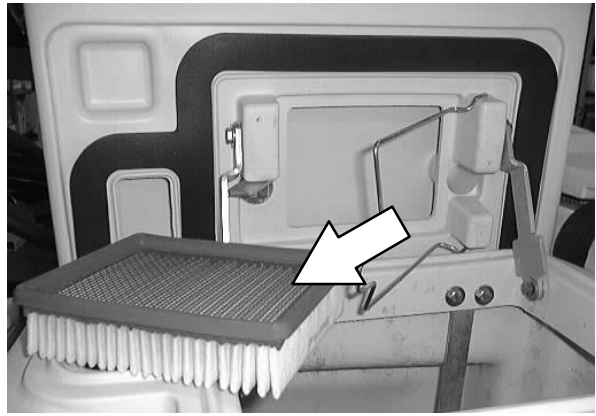

ES option: The ES filter should be cleaned daily.

The outside of the tank can be cleaned with vinyl cleaner.

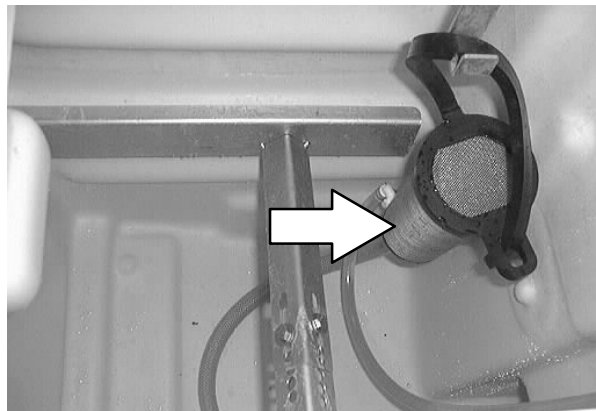

SOLUTION TANK

The solution tank stores the cleaning solution.

The solution tank does not require regular maintenance. If deposits form on the bottom of the tank, rinse the tank with a strong blast of warm water. The tank can be flushed through the fill opening. Drain the tank with the solution tank drain hose. See *DRAINING AND CLEANING THE TANKS* section of this manual.

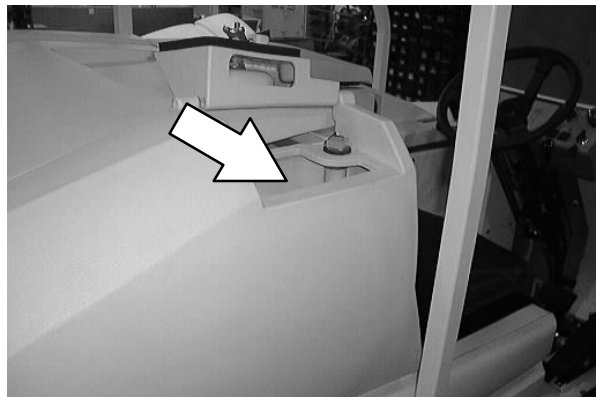

ES option: The solution tank should be drained and cleaned daily. Rinse the solution outlet filters at the bottom of the tank through the drain access.

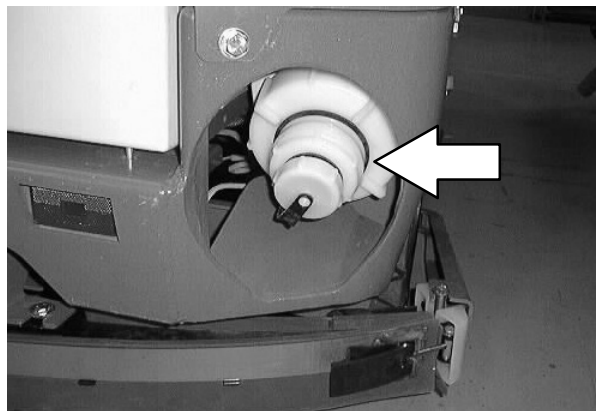

FaST SYSTEM

FaST SUPPLY HOSE CONNECTOR

The FaST supply hose connector is located below the FaST PAK holder. Soak the connector in warm water if detergent buildup is visible. When a FaST PAK carton is not installed, store the supply hose connector on the storing plug to prevent the hose from clogging.

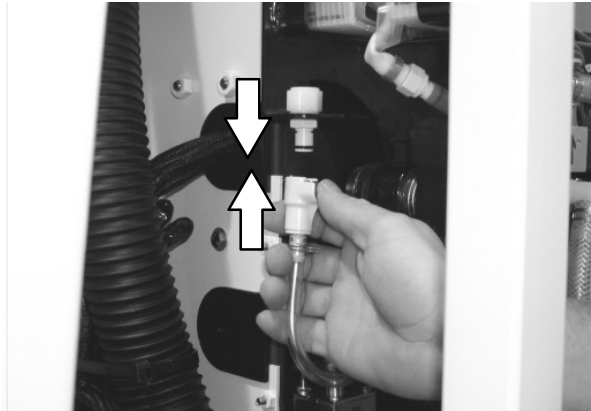

FaST SYSTEM FILTER SCREEN

The FaST system filter screen is located under the solution tank and filters the water from the solution tank as it flows into the FaST system.

Remove the filter screen bowl and clean the filter screen after every 50 hours of machine operation. Empty the solution tank before removing the filter.

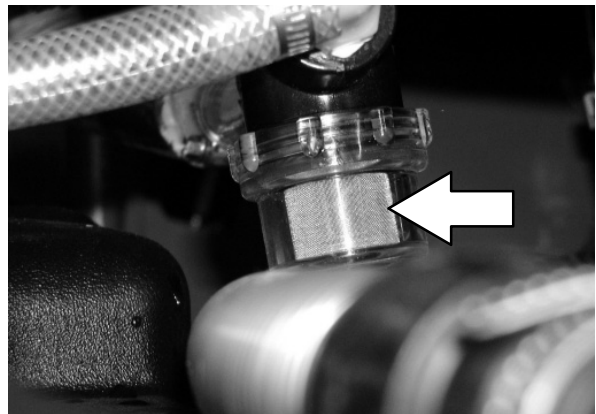

FaST SYSTEM AIR PUMP FILTER (S/N 000000–003746)

The FaST system air pump filter is located on the side of the air pump.

Remove and clean out the air filter with compressed air after every 200 hours of FaST scrubbing.

FOR SAFETY: When servicing machine, wear eye protection when using pressurized air or water.

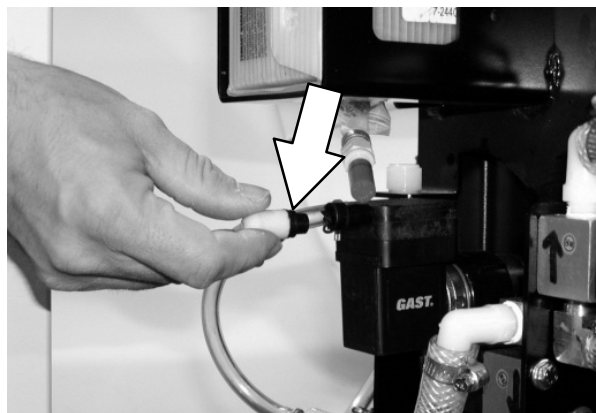

**FaST SYSTEM AIR PUMP FILTER
(S/N 003747-)**

The FaST system injector filters are located under the FaST-PAK holder.

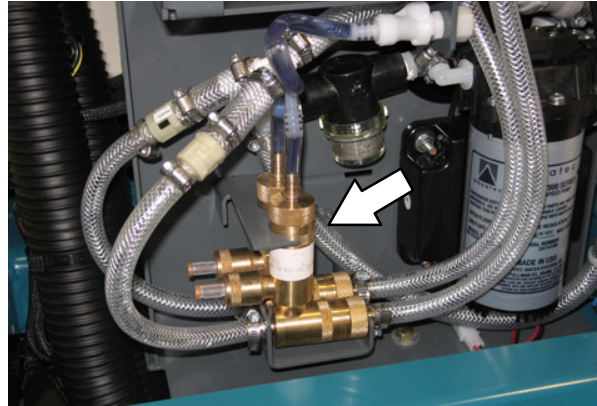

Replace the FaST system injector filters after every 1000 hours of operation. Empty the solution tank before replacing the filters.



ec-H2O MODULE FLUSH PROCEDURE

This procedure is only required when an alarm sounds and the *ec-H2O* system indicator light begins to blink red.

1. Remove the siphon hose from the retainer.

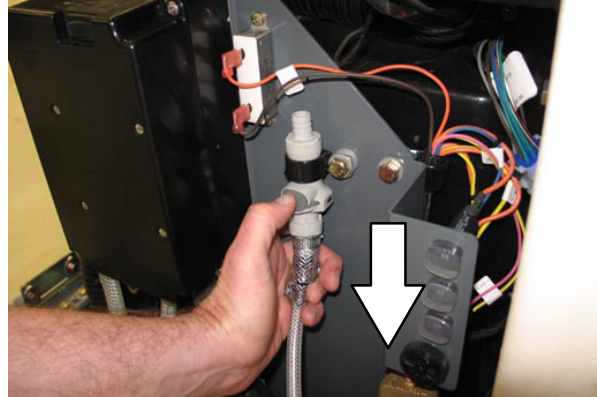

2. Disconnect the *ec-H2O* system intake hose from the solution supply hose and the *ec-H2O* system outlet hose from the hose to the scrub head.
3. Connect the siphon hose to the *ec-H2O* system intake hose and place the siphon hose into container containing 2 gallons (7.6 liters) of white or rice vinegar.

NOTE: Use **white or rice vinegar** only. The acidity level should be between 4–8%. **Do not** use other acids for this procedure.

FOR SAFETY: When servicing machine, wear protective gloves and eye protection when handling vinegar.

4. Place the *ec-H2O* system intake hose into a empty bucket.

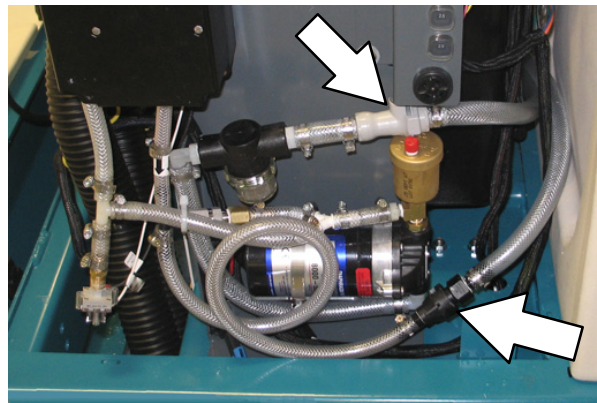

5. Turn the key to the on (I) position.

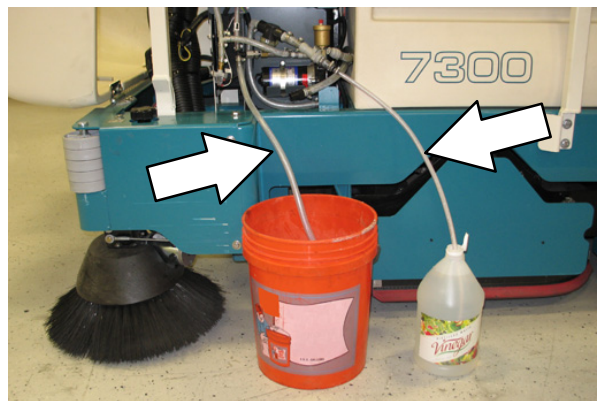

6. Press the top of the *ec-H2O* switch to place the *ec-H2O* system into low.

*NOTE: The *ec-H2O* system must be placed into low before it can be flushed.*



7. Press and release the *ec-H2O* module flush switch to start the flush cycle.

NOTE: The module will automatically shut off when the flush cycle is complete (approx. 7 minutes). The module must run the full 7 minute cycle in order to reset the system indicator light and alarm.

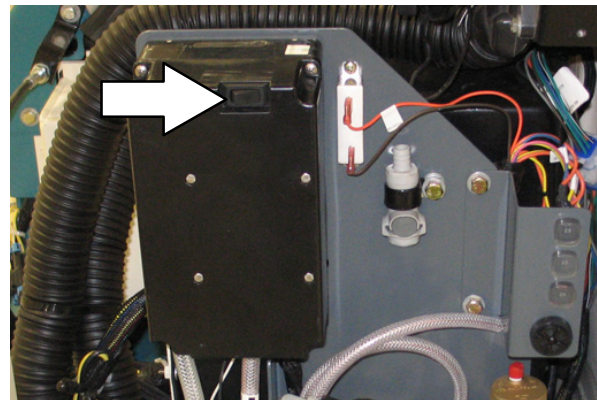

8. After the 7 minute flush cycle, remove the siphon hose from the container of vinegar and place the siphon hose into a container of cool clean water. Press the flush switch again to rinse out any remaining vinegar from the module. After 1–2 minutes, press the flush switch to turn off the module.
9. Disconnect the siphon hose from the *ec-H2O* system intake hose.
10. Reconnect *ec-H2O* intake and outlet hoses. If the *ec-H2O* system indicator light continues to flash, repeat the flush procedure. If the problem persists, contact an Authorized Service Center.
11. Reconnect the siphon hose to the retainer and neatly coil the hose for storage.

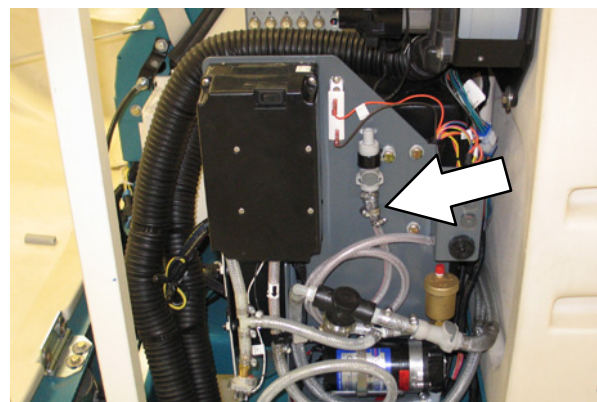

SQUEEGEES

As the machine travels forward the squeegees wipe the dirty solution off the floor, which is then picked up and drawn into the recovery tank. The front blade channels the water, and the rear blade wipes the floor.

The side squeegees control water spray and channel water into the path of the rear squeegee.

REAR SQUEEGEE

Check the squeegee blades for damage and wear daily. Rotate or replace either of the squeegee blades if the leading edge is torn or worn half-way through the thickness of the blade.

The squeegee can be adjusted for leveling and deflection. The deflection and leveling of the squeegee blades should be checked daily, or when scrubbing a different type of floor.

LEVELING THE REAR SQUEEGEE

Leveling of the squeegee assures even contact the length of the squeegee blade with the surface being scrubbed. Make sure this adjustment is done on an even, level floor.

1. Turn the machine power on.
2. Lower the squeegee.
3. Set the machine parking brake while the driving machine slowly forward, and turn the machine power off.

FOR SAFETY: Before leaving or servicing machine; stop on level surface, set parking brake, turn off machine and remove key.

4. Look at the deflection of the squeegee blade, over the full length of the squeegee blade.

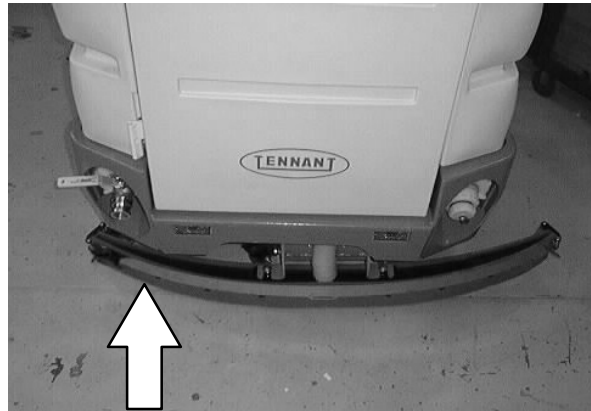

5. If the deflection is not the same over the full length of the blade, adjust the deflection by turning the leveling adjustment screw.

Turn the leveling adjustment screw clockwise to increase the deflection at the ends of the squeegee blade.

Turn the leveling adjustment screw counter-clockwise to decrease the deflection at the ends of the squeegee blade.

6. Release the parking brake and drive the machine forward again with the squeegee down to check the squeegee blade deflection.
7. Readjust the squeegee level if necessary.

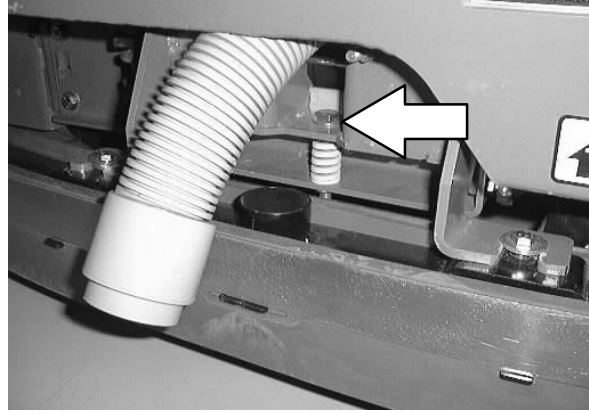

ADJUSTING REAR SQUEEGEE BLADE DEFLECTION

Deflection is the amount of curl the squeegee blade has when the machine moves forward with the squeegee lowered to the floor. The best deflection is when the squeegee wipes the floor just dry with a minimum amount of deflection.

1. Turn the machine power on.
2. Lower the squeegee.
3. Set the machine parking brake while driving the machine slowly forward, and turn the machine power off.

FOR SAFETY: Before leaving or servicing machine; stop on level surface, set parking brake, turn off machine and remove key.

4. Look at the deflection of the squeegee blade. The correct amount of deflection is 15 to 20 mm.

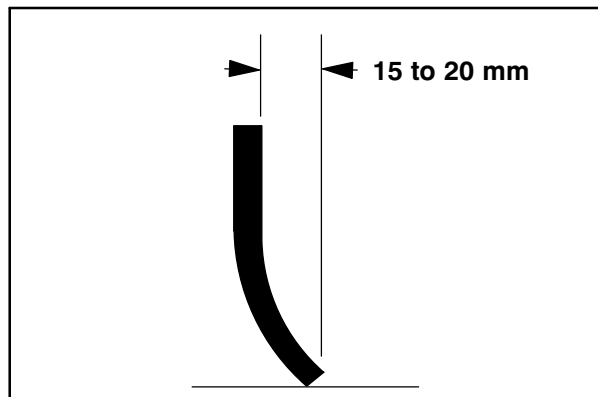

03719

MAINTENANCE

5. To adjust the amount of deflection, loosen the caster jam nut. Turn the caster shaft using the flats.

Turn the shaft clockwise to decrease the blade deflection. Turn the shaft counter-clockwise to increase blade deflection. Tighten the jam nut.

NOTE: Be sure to turn each shaft the same number of turns.

6. Release the parking brake and drive the machine forward again to check the squeegee blade deflection.
7. Readjust the squeegee blade deflection if necessary.

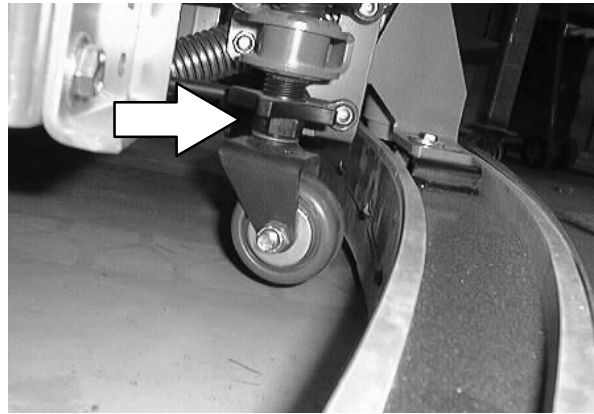

REMOVING THE REAR SQUEEGEE ASSEMBLY

1. Lower the squeegee to approximately 25mm (1 in) from the floor.
2. Turn the machine power off and set the parking brake.
3. Remove the squeegee suction hose from the top of the rear squeegee.

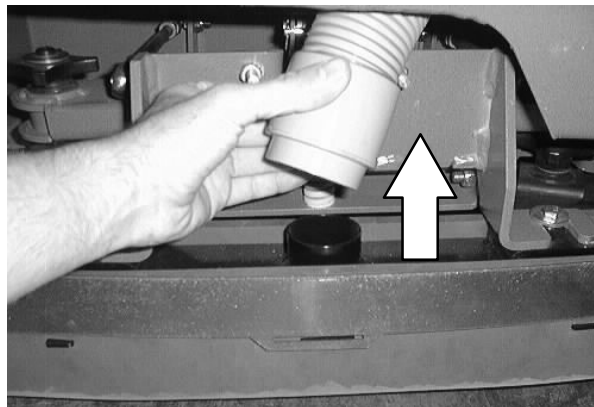

4. Loosen both squeegee mounting knobs.

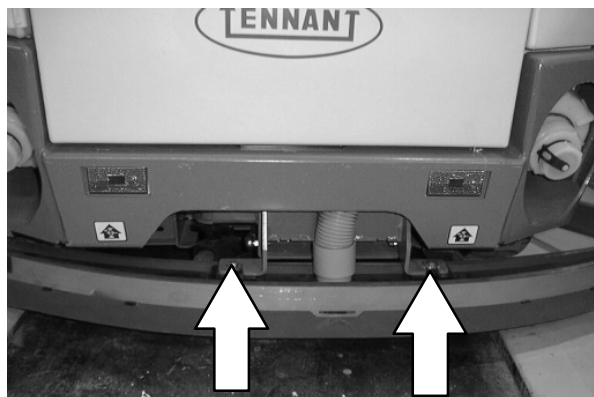

5. Pull the squeegee off the machine.

SIDE SQUEEGEE

ADJUSTING THE SIDE SQUEEGEE

The side squeegee has one adjustment; height. To change the height adjustment, loosen the adjustment nuts. Raise or lower the squeegee with the adjustment screws. Tighten the adjustment nuts. The factory setting is toward the lower end of the adjustment screw.

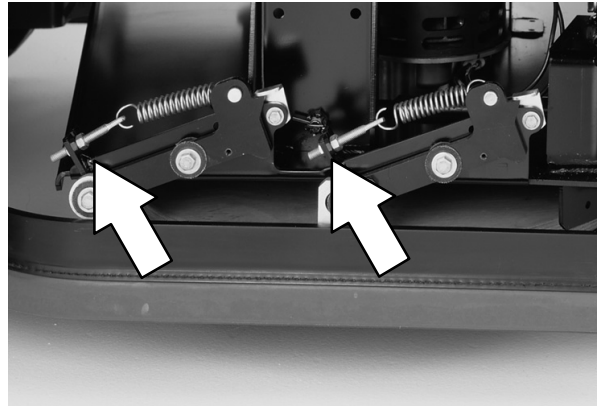

SQUEEGEE BLADES

The rear squeegee assembly channels water into the vacuum fan suction. The front blade channels the water, and the rear blade wipes the floor.

The side squeegees control water spray and channel water into the path of the rear squeegee.

Replace any worn or damaged squeegee blades.

REAR SQUEEGEE BLADES

Check the squeegee blades for damage and wear daily. Rotate or replace either of the squeegee blades if the leading edge is torn or worn half-way through the thickness of the blade.

The squeegee has two squeegee blades, the front and rear. Each blade has four wiping edges. To use them all, start with one wiping edge. To use the next wiping edge, rotate the blade end-for-end. To use the next wiping edge, rotate the top edges down, bottom edges up. To use the last edge, rotate the blade end-for-end.



REPLACING OR ROTATING THE REAR SQUEEGEE BLADES

1. Make sure the squeegee is raised off the floor.
2. Turn the machine power off and set the parking brake.

FOR SAFETY: Before leaving or servicing machine; stop on level surface, turn off machine.

MAINTENANCE

3. Release the squeegee retainer strip clamp on the right hand side of the squeegee.
4. Remove the squeegee retainer strip.
5. Pull the squeegee blades off the squeegee frame.
6. Replace or rotate the squeegee blades to allow a new edge to face the front of the machine.
7. Mount the squeegees back onto the squeegee frame.



NOTE: Lubricating the squeegee frame where the squeegee makes contact will make it easier to install the squeegee blade.

8. Mount the retainer strip back over the squeegee blades. Secure the retainer strip with the retainer strip clamp.
9. Adjust the rear squeegee as described in **LEVELING THE REAR SQUEEGEE** and **ADJUSTING REAR SQUEEGEE BLADE DEFLECTION**.



SIDE SQUEEGEES BLADES

The side squeegees control water spray and channel water into the path of the rear squeegee. Check the side squeegees for damage and wear daily.

REPLACING THE SIDE SQUEEGEE BLADES

Replace the side squeegee blades whenever they become damaged or lose their shape or resiliency. Reverse the squeegee point guides from one side squeegee to the opposite side whenever they become worn, or replace when they become worn on both sides.

1. Raise the scrub head.
2. Turn the machine power off and set the parking brake.

FOR SAFETY: Before leaving or servicing machine; stop on level surface, set parking brake, turn off machine and remove key.

3. Remove the cotter pin, clevis pin, point guide, and the retainer bracket from the front of the side squeegee.
4. Pull the squeegee blade off the front of the squeegee frame.

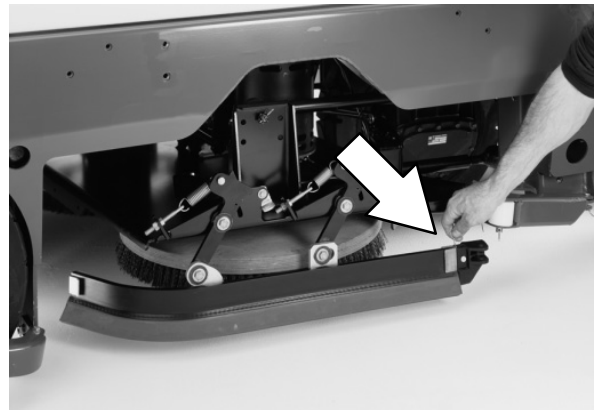

5. Slide the new squeegee blade onto the frame.

NOTE: Lubricating the squeegee frame where the squeegee makes contact will make it easier to install the squeegee blade.

6. Replace the retainer bracket, deflector, clevis pin, and cotter pin.
7. Repeat for the side squeegee on the other side of the scrub head.

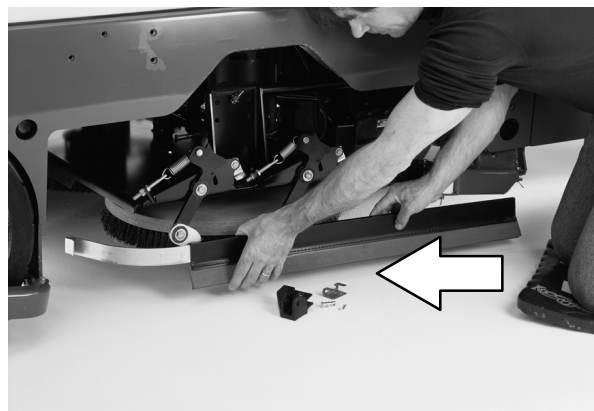

BELTS AND CHAINS

BRUSH DRIVE BELTS

The two brush drive belts are located on the cylindrical brush scrub head. The belts drive the cylindrical brushes. Proper belt tension is a 4 mm (0.16 in) deflection from a force of 1.8 to 2.0 kg (4 to 4.4 lbs) at the belt midpoint.

Check the belts for damage and wear after every 100 hours of operation.

FOR SAFETY: When servicing machine, avoid moving parts. Do not wear loose jackets, shirts, or sleeves when working on machine.

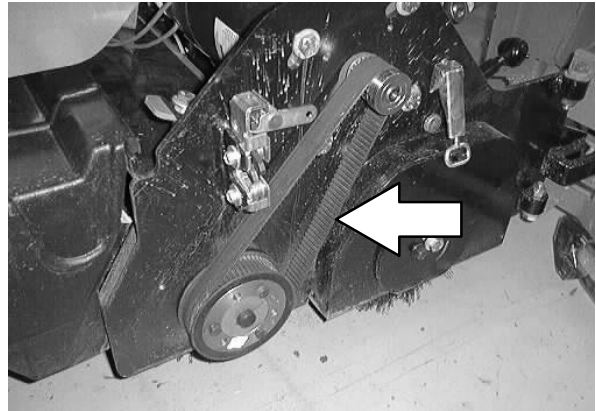

STEERING GEAR CHAIN

The steering gear chain tension should be checked after the first 50 hours of operation and every 500 hours thereafter. The deflection should be 3 to 6 mm (0.12 to 0.24in) between the steering sprocket and the idler sprocket when the steering wheel is turned the tightest position either direction.

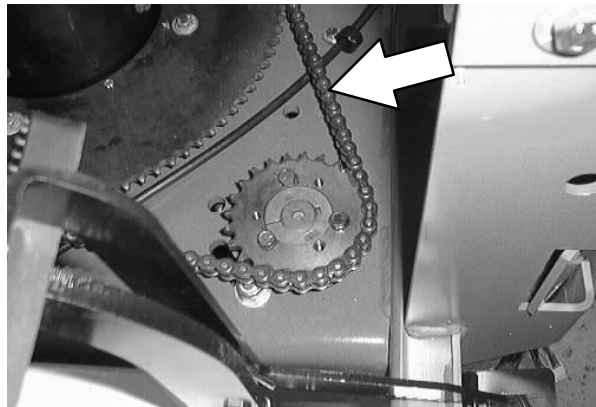

STATIC DRAG CHAIN

A static drag chain prevents the buildup of static electricity in the machine. The chain is attached to the transaxle.

Make sure the chain is always touching the floor.

SKIRTS AND SEALS

SCRUB HEAD FLOOR SKIRTS

The skirts are located in front and rear of the disc brush scrub heads. Check the skirts for damage and wear every 50 hours of operation.

The skirts should clear the floor by 0 to 6 mm (0 to 0.24in) when the scrub brushes are new, and the scrub head is down.

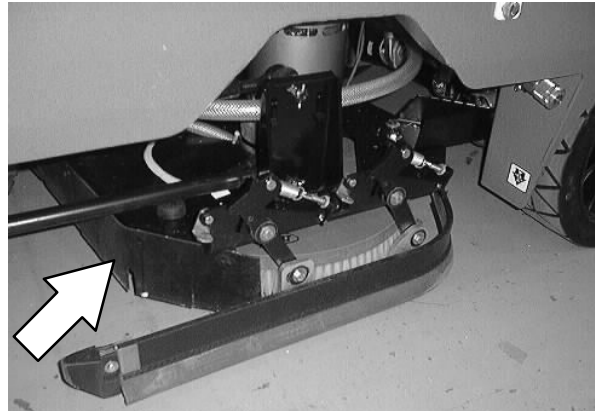

FRONT COVER SEALS

The front cover seals are located around the edge of the opening between the front cover, operator compartment, and solution recovery tank.

Check the seals for wear or damage every 100 hours of operation.

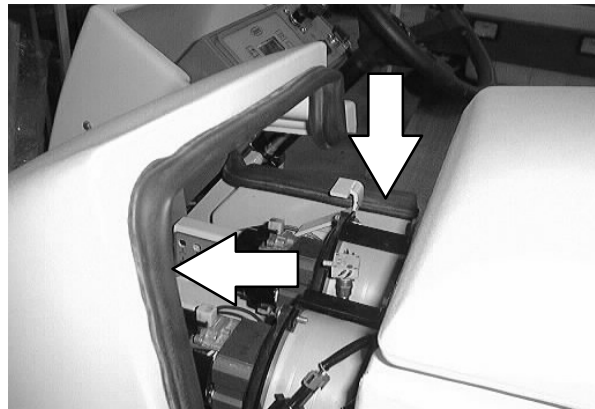

MAINTENANCE

SOLUTION TANK COVER SEAL

The solution tank cover seal is located under the solution tank cover.

Check the seal for wear or damage every 100 hours of operation.



RECOVERY TANK COVER SEAL

The recovery tank cover seal is located under the recovery tank cover.

Check the seal for wear or damage every 100 hours of operation.

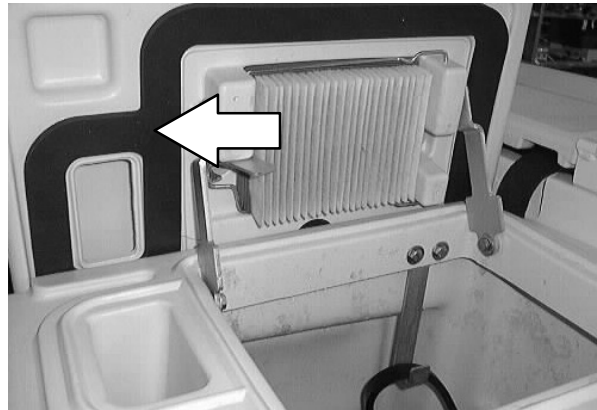

BRAKES AND TIRES

BRAKES

The foot brake and the parking brake operate the linkage that controls the brakes on the rear wheels.

The foot pedal should not travel more than 25 mm (1in) to engage the brake. Check the brake adjustment after every 100 hours of operation.

Park the machine on a level surface. Turn the machine power off, and block the machine tires.

Loosen the adjustment nuts. Adjust the brake cable with one nut and lock in place with the other nut.

Adjust the brake cable so that the brake pedal travels no more than 25 mm (1in) to fully engage the brakes. Readjust the brake cable if necessary.

Remove the blocks from the machine tires.

TIRES

All the machine tires are solid. Check the tires for wear every 100 hours of operations.

FRONT WHEEL

Torque the front wheel nuts twice in the pattern shown to 122 to 155 Nm (87–111 ft. lbs) after the first 50 hours of operation, and every 500 hours of operation.

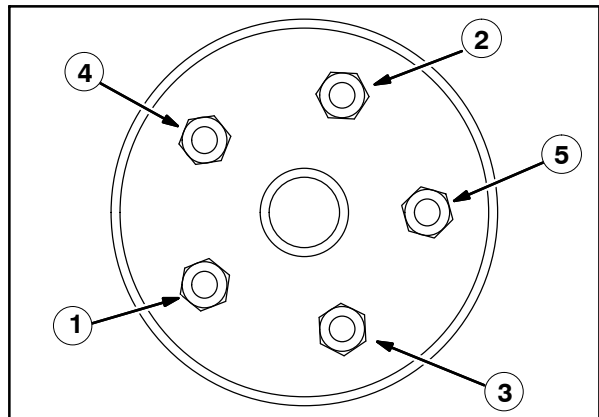

PUSHING, TOWING, AND TRANSPORTING THE MACHINE

PUSHING OR TOWING THE MACHINE

If the machine becomes disabled, it can be pushed from the front or rear, but only tow it from the front.

Only push or tow the machine for a *very short distance* and do not exceed 3.2 kph (2mph). It is NOT intended to be pushed or towed for a long distance or at a high speed.

ATTENTION! Do not push or tow machine for a long distance or damage may occur to the propelling system.

TRANSPORTING THE MACHINE

1. Position the front of the machine at the loading edge of the truck or trailer.

FOR SAFETY: Use truck or trailer that will support the weight of the machine.

NOTE: Empty the solution and recovery tanks before transporting the machine.

2. If the loading surface is not horizontal or is higher than 380 mm (15in) from the ground, use a winch to load machine.

If the loading surface is horizontal AND is 380 mm (15in) or less from the ground, the machine may be driven onto the truck or trailer.

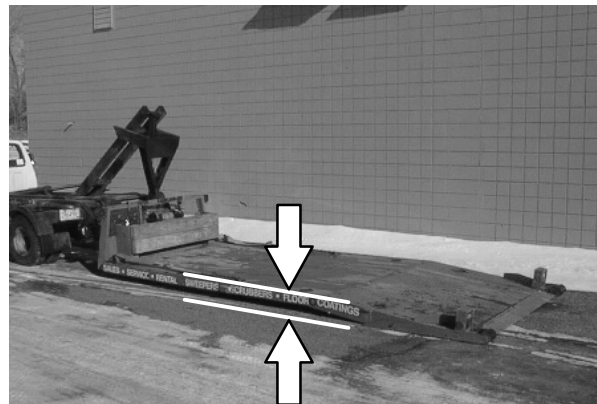

3. To winch the machine onto the truck or trailer, attach the winching chains to the front tie down locations. The front tie-down locations are on the front sides of the machine. Make sure the machine is centered.

FOR SAFETY: When loading machine onto truck or trailer, use winch. Do not drive the machine onto the truck or trailer unless the loading surface is horizontal AND is 380 mm (15in) or less from the ground.



4. Position the machine onto the truck or trailer as far as possible. If the machine starts to veer off the centerline of the truck or trailer, stop and turn the steering wheel to center the machine.
5. Set the parking brake and block the machine tires. Tie down the machine to the truck or trailer before transporting.

The front tie-down locations are on the front sides of the machine.



The rear tie-down locations are on the rear sides of the machine.

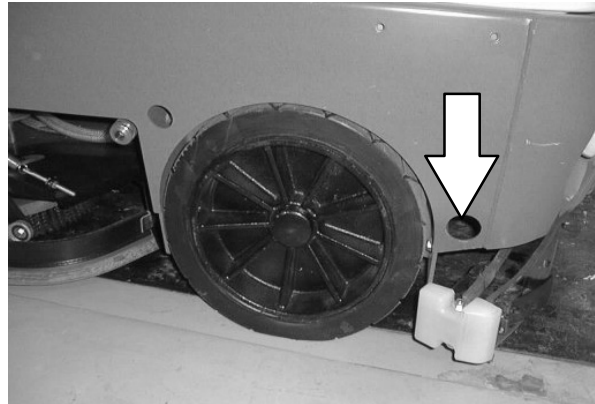

6. If the loading surface is not horizontal or is higher than 380 mm (15in) from the ground, use a winch to unload machine.

If the loading surface is horizontal AND is 380 mm (15in) or less from the ground, the machine may be driven off the truck or trailer.

FOR SAFETY: When unloading machine off truck or trailer, use winch. Do not drive the machine off the truck or trailer unless the loading surface is horizontal AND 380 mm (15in) or less from the ground.

MACHINE JACKING

Empty the solution and recovery tanks before jacking the machine. You can jack up the machine for service at the designated locations. Use a hoist or jack that will support the weight of the machine. Always stop the machine on a flat, level surface and block the tires before jacking up the machine.

The front jacking location is in the center of the front bumper

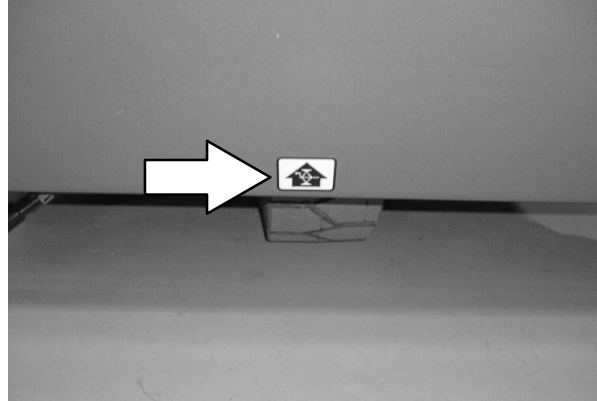

The rear jacking locations are located on the rear bumper, behind the rear tires.

Always stop the machine on a flat level surface and block the machine tires before jacking up the machine.

FOR SAFETY: When servicing machine, block machine tires before jacking machine up.

FOR SAFETY: When servicing machine, jack machine up at designated locations only. Block machine up with jack stands.

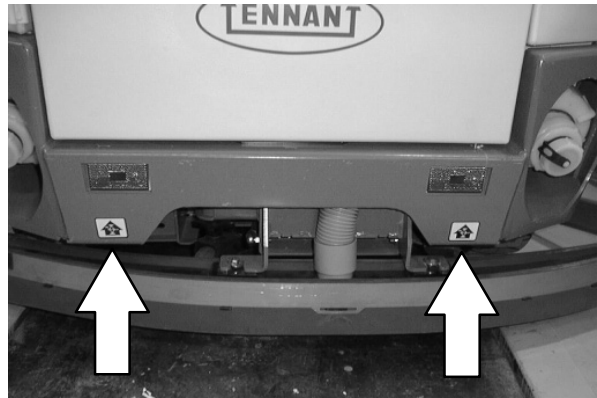

STORAGE INFORMATION

The following steps should be taken when storing the machine for extended periods of time.

1. Drain and clean the solution and recovery tanks.

ES machines: Run clean water through the solution system and the ES solution pump.

2. Raise the rear squeegee and the scrub head.
3. Park the machine in a cool, dry area.
4. Remove the batteries, or charge them after every three months.

NOTE: Storing or transporting machines equipped with the ES or the FaST system in freezing temperatures requires special procedures. Consult a TENNANT representative for more information.

FREEZE PROTECTION (MACHINES WITHOUT OPTIONAL *ec*-H₂O SYSTEM)

1. Drain the solution tank and recovery tank of all water.
2. Pour 6 gallons (3.8 liters) of Propylene Glycol Based / Recreational Vehicle (RV) Antifreeze into the solution tank at full strength. Do not dilute.
3. Turn the machine power on and operate the solution flow system. Turn the machine off when the antifreeze appears at the scrub head.

If the machine is equipped power wand option, operate the the wand for a few seconds to protect the pump.

MAINTENANCE

FREEZE PROTECTING THE *ec-H2O* SYSTEM

1. Completely empty the solution tank and recovery tank.
2. Start the machine and run all remaining solution from the solution system. Run the solution system until solution no longer appears at the scrub head.
3. Remove the siphon hose from the retainer.

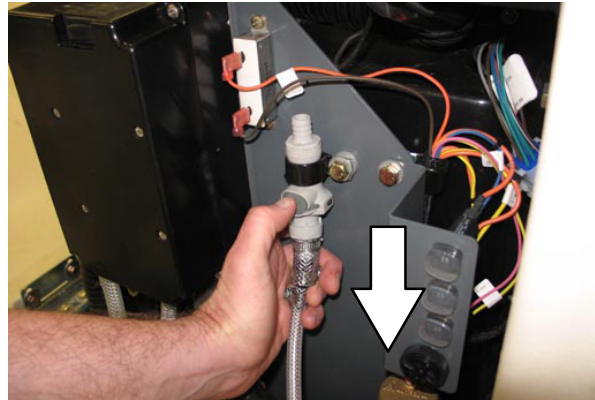

4. Disconnect the *ec-H2O* system intake hose from the solution supply hose.
5. Connect the siphon hose to the *ec-H2O* system intake hose and place the siphon hose into container containing 2 gallons (7.6 liters) of Propylene Glycol Based / Recreational Vehicle (RV) Antifreeze.

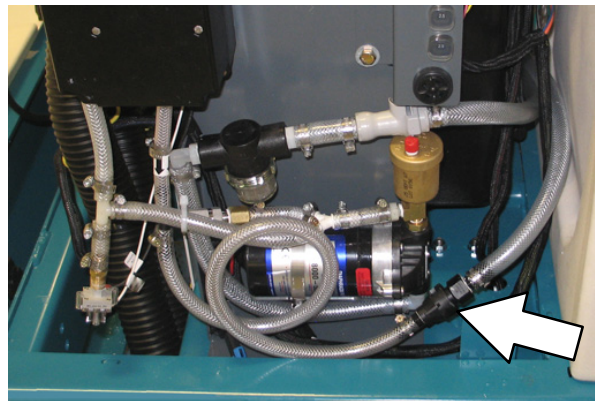

6. Press and release the flush switch on the *ec-H2O* module to cycle the RV antifreeze through *ec-H2O* system. When the antifreeze appears at the scrub head, press the switch again to turn off the module.
7. Disconnect the siphon hose from the *ec-H2O* system intake hose.
8. Reconnect *ec-H2O* intake hose to the solution supply hose.

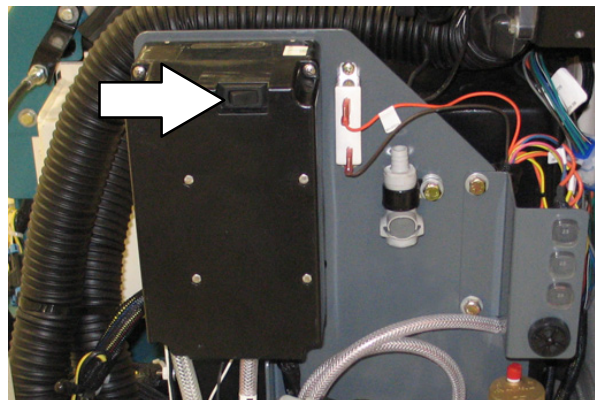

9. Reconnect the siphon hose to the retainer and neatly coil the hose for storage.

IMPORTANT: Before operating the machine, the antifreeze must be flushed from the module. See *FLUSHING ANTIFREEZE FROM ec-H2O MODULE* section of this manual.

10. If machine is equipped power wand option, operate the the wand for a few seconds to protect the pump.

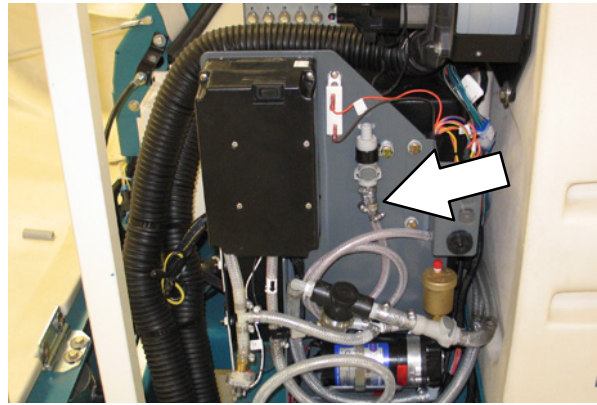

MAINTENANCE

FLUSHING ANTIFREEZE FROM THE *ec-H2O* MODULE

1. Remove the siphon hose from the retainer.

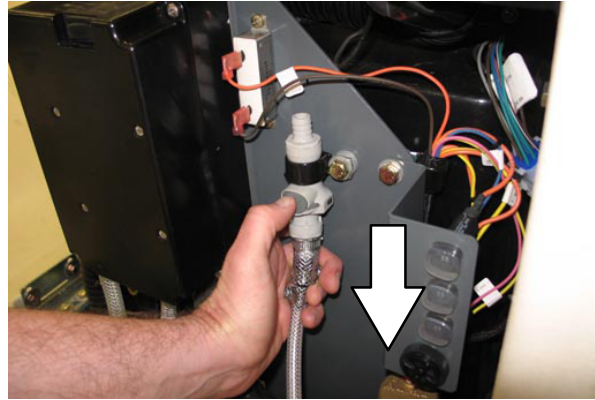

2. Disconnect the *ec-H2O* system intake hose from the solution supply hose.
3. Connect the siphon hose to the *ec-H2O* system intake hose and place the siphon hose into container containing 2 gallons (7.6 liters) of clean water.

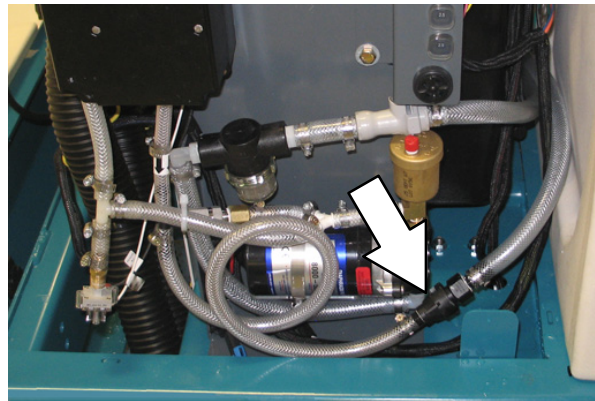

4. Press and release the *ec-H2O* module switch to flush the antifreeze from the *ec-H2O* system.

When the water turns clear, press the module switch again to stop the flush cycle.

Dispose the antifreeze in an environmentally safe way according to local waste disposal regulations.

5. The machine is now ready for scrubbing.

ATTENTION: If the antifreeze is not properly flushed from the *ec-H2O* system, the *ec-H2O* module may detect an error and not function (*ec-H2O* indicator light will turn red). If this occurs, reset key and repeat the flush procedure.

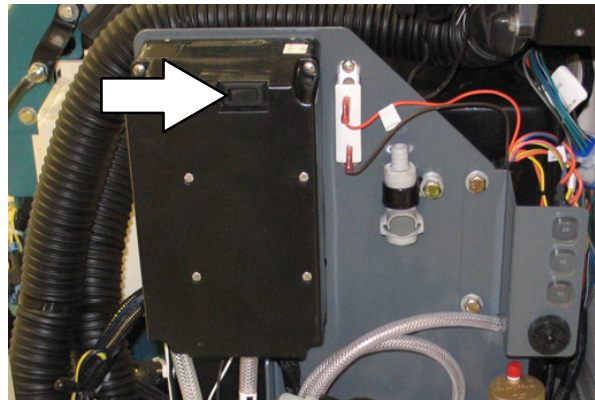

SPECIFICATIONS

GENERAL MACHINE DIMENSIONS/CAPACITIES

Item	Dimension/capacity
Length	2134 mm (84 in)
Width, frame	1143 mm (45 in)
Width, frame with right hand side brush (option)	1282 mm (50.5 in)
Width, frame with dual side brush (option)	1422 mm (56 in)
Width with rear squeegee	1300 mm (51 in)
Width with MaxPro 1200 scrub head option	1510 mm (53 in)
Height	1450 mm (57 in)
Height with overhead guard option	2070 mm (81.5 in)
Disc brush diameter for Max Pro 1000	510 mm (20 in)
Disc brush diameter for Max Pro 1200	406 mm (16 in)
Cylindrical brush diameter	229 mm (9 in)
Cylindrical brush length for Max Pro 1000	978 mm (38.5 in)
Cylindrical brush length for Max Pro 1200	1180 mm (46.5 in)
Rear Squeegee width for Max Pro 1000	1300 mm (51 in)
Rear Squeegee width for Max Pro 1200	1510 mm (59.5 in)
Scrubbing path width for Max Pro 1000	1020 mm (40 in)
Scrubbing path width for Max Pro 1200	1220 mm (48 in)
Solution tank capacity	216 L (57 gal)
Recovery tank capacity	216 L (57 gal)
Tank capacity with ES option	340 L (90 gal)
Propelling gear box 90 wt. gear lubricant capacity	2.7 L (2.7 qt)
GVWR	2060 kg (4580 lb)
Vibration level at steering wheel does not exceed	2.5 m/s ²
Vibration level at operator seat does not exceed	0.5 m/s ²

FaST SYSTEM

Item	Measure
Solution pump	36 Volt DC, 5A, 5.7 LPM (1.5 GPM) open flow, 45 psi bypass setting
Low solution flow rate	2.08 LPM (0.55 GPM)
High solution flow rate	4.16 LPM (1.1 GPM)
Detergent pump	36 Volt DC
Low concentrate flow rate	2.14 CC/Minute (0.07 Liquid Ounces/Minute)
High concentrate flow rate	4.28 CC/Minute (0.14 Liquid Ounces/Minute)
Air pump	36 Volt DC, 0.6 Maximum Amp draw
Air pump flow rate	8.7 LPM (0.3 CFM) open flow

SPECIFICATIONS

GENERAL MACHINE PERFORMANCE

Item	Measure
Maximum forward speed	7.2 km/h (4.5 mph)
Maximum reverse speed	4.8 km/h (3mph)
Minimum turning radius, left	3620 mm (142.5 in)
Minimum turning radius, right	3680 mm (145 in)
Minimum isle turn width	2410 mm (95 in)
Maximum rated climb and descent angle with full tanks	6°
Maximum rated climb and descent angle with empty tanks	8°

POWER TYPE

Type	Quantity	Volts	Ah Rating	Weight
Batteries, Dry	1	36	500 @ 6 hr rate	617 kg (1370 lb)
	1	36	750 @ 6 hr rate	893 kg (1984 lb)
Batteries, Sealed	1	36	600 @ 6 hr rate	810 kg (1800 lb)
Batteries, Wet	1	36	380 @ 6 hr rate	436 kg (960 lb)
	1	36	500 @ 6 hr rate	617 kg (1370 lb)
	1	36	750 @ 6 hr rate	893 kg (1984 lb)

Type	Use	VDC	Kw (hp)
Electric Motors	Scrub brush	36	0.75 (1)
	Heavy Duty scrub brush	36	1.12 (1.5)
	Vacuum fan	36	0.63 (0.85)
	Propelling	36	3.4 (4.6)

Type	VDC	amp	Hz	Phase	VAC
Chargers	36	75	60	1	208-240-480
	36	75	60	3	208-240-480
	36	120	60	1	208-240-480
	36	120	60	3	208-240-480
	36	150	60	1	208-240-480
	36	150	60	3	208-240-480
	36	93	60	1	208-240-480
	36	93	60	3	208-240-480

STEERING

Type	Power source	Emergency steering
Front wheel controlled, universal joint to gear and chain	Manual	Manual
Front wheel, hydraulic cylinder and rotary valve controlled	Hydraulic (Option)	Manual

HYDRAULIC SYSTEM

System	Capacity	Fluid Type
Hydraulic reservoir (Power Steering Option)	1.9L (0.5 gal)	ISO Grade 32 – below 7° C (45° F)
Hydraulic total (Power Steering Option)	2.3L (0.6 gal)	

BRAKING SYSTEM

Type	Operation
Service brakes	Mechanical drum brakes (2), one per rear wheel, cable actuated
Parking brake	Utilizes service brakes, cable actuated

TIRES

Location	Type	Size
Front (1)	Solid	413 X 152 mm (16.25 x 6 in)
Rear (2)	Solid	406 X 127 mm (16 x 5 in)

ec-H2O SYSTEM

Item	Measure
Solution pump	36 Volt DC, 5A, 5.7 LPM (1.5 GPM) open flow, 45 psi bypass setting
Solution flow rate	1.67 LPM (0.44 GPM) – Low (optional)*
	2.35 LPM (0.62 GPM) – Low (standard)
	3.18 LPM (0.84 GPM) – Low (optional)*
	3.80 LPM (1.00 GPM) – High (standard)

*If the optional solution flow rates are required, contact an Authorized Service Center.

SPECIFICATIONS

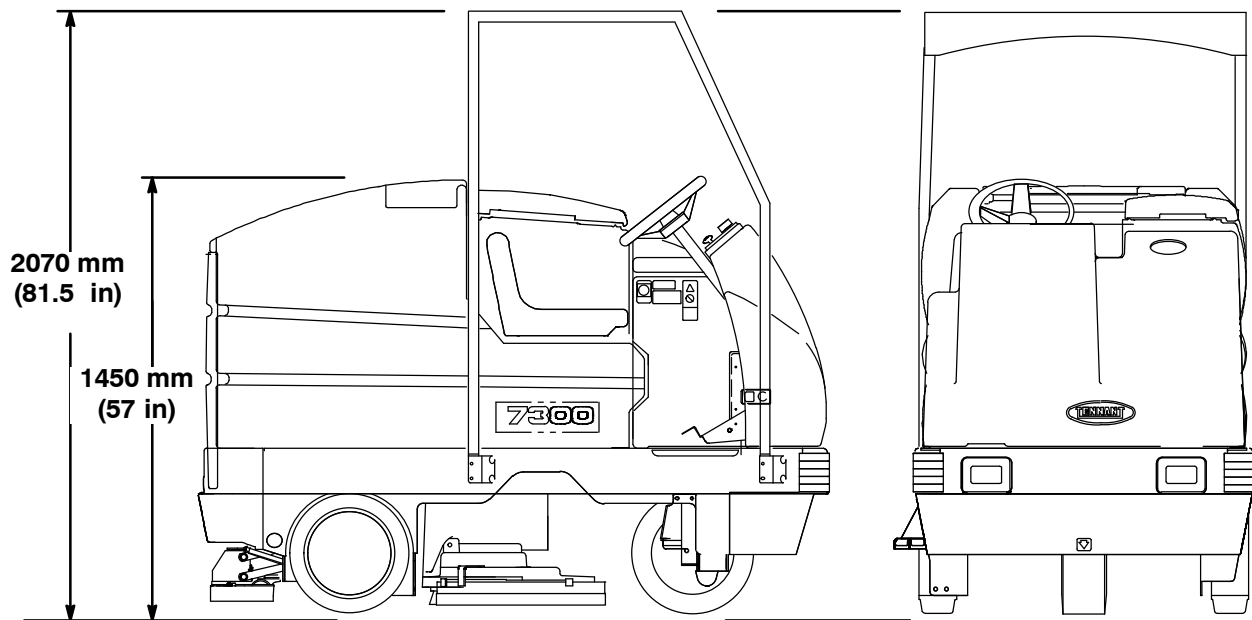
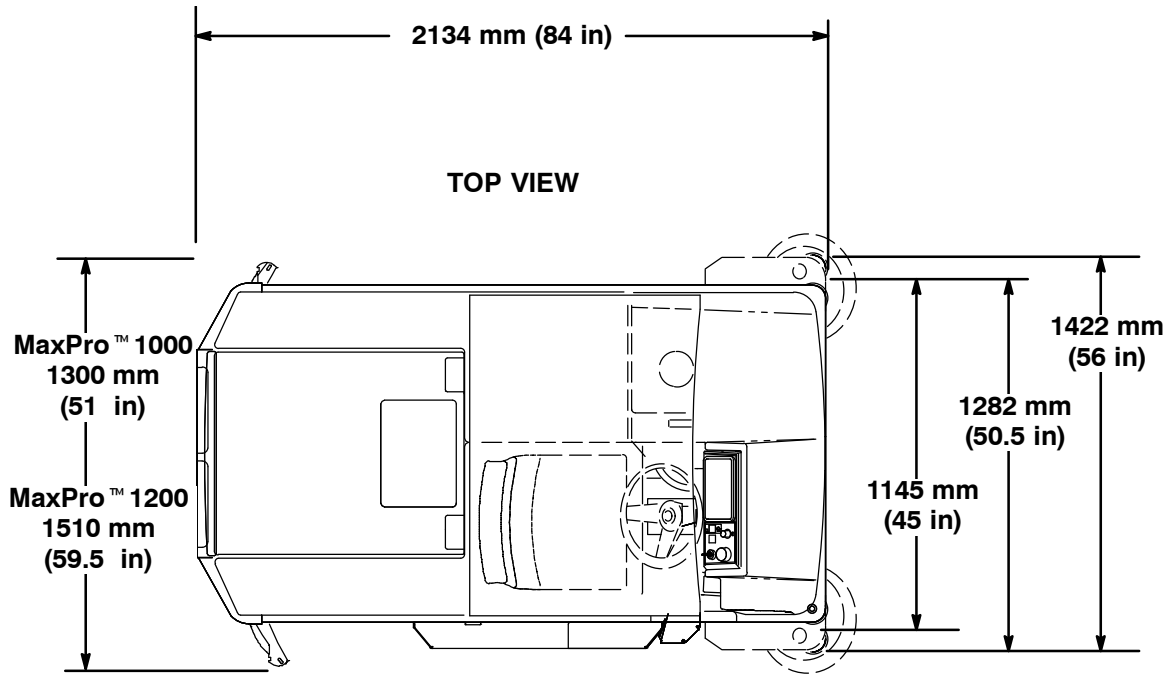

SIDE VIEW

FRONT VIEW

MACHINE DIMENSIONS

A

Adjusting rear squeegee blade deflection, 100
 Adjusting the side squeegee, 102
 Adjustments, Service brakes, 108
 Aisle turn, 117
 Adjustments, Steering gear chain, 105

B

Batteries, 77–80
 Charger specifications, 117
 Charging, 78–80
 Discharge indicator, 17
 Maintenance, 77
 Specifications, 117
 Battery, Fluid level, 36, 57
 Battery discharge indicator, 17
 Bearings
 Front wheel support, 72
 Rear wheel, 74
 Belts, Brush drive, 105
 Belts and chains, 105
 Brake pedal, 10
 Brakes, 36, 57, 108
 Brakes and Tires, 108
 Braking system, Specifications, 118
 Brush drive belts, 105
 Brush pressure adjustment, scrubbing, 19
 Brushes
 information, recommendations, 43
 Maintenance, 36, 57
 Scrubbing, 43
 Side sweeping brush replacement, 92
 Button, Horn, 12

C

Capacities, 116
 Chain, Steering gear, 74
 Chains
 Static drag, 105
 Steering gear, 105
 Changing message display language, 16
 Circuit breakers, 28

Control panel, 19
 Battery discharge indicator, 17
 Changing message display language, 16
 detergent pump switch (option), 24
 Display clock, 18
 display clock setting & adjusting, 18
 Edge scrub switch, 21
 ES switch, 21
 functions, 15
 Hourmeter, 17
 maintenance mode, 24, 25, 26
 Rear squeegee switch, 22
 Recovery tank full indicator, 21
 Self-diagnostics, 80
 Side brush switch (option), 23
 Super Scrub switch, 20
 Controls, 9
 Battery discharge indicator, 17
 Brake pedal, 10
 Circuit breakers, 28
 Directional pedal, 10
 ec-H₂O switch (option), 15
 Edge scrub, 21
 ES switch, 21
 FaST switch (option), 14
 Horn button, 12
 Hourmeter, 17
 On-off key switch, 12
 Operating lights switch, 13
 Parking brake pedal, 10
 Power kill switch, 13
 Power wand switch, 13
 Rear squeegee switch, 22
 Recovery tank full indicator, 21
 Scrub switch, 19
 Side brush (Option), 23
 Side brush adjustment knob (Option), 32
 Solution flow lever, 14
 Steering wheel, 11
 Steering wheel column tilt lever, 14
 Cylindrical brushes
 Checking and adjusting brush pattern, 87–89
 Replacing brushes, 90

D

Debris tray, Clean, 36, 57
 Detergent pump switch (option), 24
 Dimensions, 116
 Directional pedal, 10
 Display clock, 18
 setting & adjusting, 18
 Double scrubbing, 50
 Draining and cleaning the tanks, 51–53

E

ec—H2O module flush procedure, 97
ec—H2O Scrubbing System, Indicator Light Codes, 46
ec—H2O Scrubbing System Indicator Light Codes , 46
ec—H2O switch, 15
ec—H2O System, 35
Edge scrub switch, 21
Electric motors, 82, 117
Electrical
 Batteries, 77–80
 Charging batteries, 78–80
 Circuit breakers, 28
Electrical system, fuses, 27
Electronics, Propelling circuit, 82
ES
 Auto-fill, 42
 Clean tanks, 36, 57
 Detergent level, 36, 57
 Filling the tanks, 40–42
ES switch, 21

F

FaST, System, 95
FaST pak agent, Installing, 37–39
FaST pak agent installation, 37–39
FaST Supply Hose Connector, 95
FaST switch, 14
FaST System, 34, 95
 FaST supply hose connector, 95
FaST system, Priming the FaST solution system, 38
FaST System Air Pump Filter, 95, 96
FaST System Filter Screen, 95
Filling the tanks, 40–42
Filter
 FaST System Air Pump Filter, 95, 96
 FaST System Filter Screen, 95
 Vacuum fan inlet, 36, 57
Flush antifreeze from ec—H2O module, 115
Freeze protection, 112
Freeze protection, ec—H2O system, 113
Front cover seals, 106

Front wheel
 Support bearing, 72
 Torque, 108
Front wheel support bearing, 72
Fuses, 27

H

Horn button, 12
Hoses
 Recovery tank drain, 30
 Solution tank drain (option), 30
Hourmeter, 17
How the machine works, 33
Hydraulics, Fluid level, 36, 57
Hydraulics (option), 75
 Hydraulic fluid, 76
 Hydraulic fluid reservoir, 75
 Hydraulic hoses, 76
 Specifications, 118

I

Indicator Light Codes, ec—H2O Scrubbing System, 46
Indicators
 Recovery tank full, 21
 Scrub brush pressure, 19

J

Jack points, 111
Jacking, 111

K

Knobs, Side brush adjustment (Option), 32

L

Latches, 30
Leveling the rear squeegee, 99
Levers
 Solution flow, 14
 Steering wheel column tilt, 14

Lubrication, 72

- Front wheel support bearing, 72
- Propelling gearbox, 72
- Rear wheel bearings, 74
- Scrub head drag link arms, 73
- Steering gear chain, 74

M

Machine, Jacking, 111

Machine components, 6

Machine dimensions, 119

Machine tie down locations, 110

Maintenance, 70–94

- Checking and adjusting brush pattern, 87–89
- Cylindrical brushes, 87
- Disk brushes, 84–89
- Intervals, 70
- Recommended, 5
- Replacing cylindrical brushes, 90
- Replacing disk brushes, 84
- Scrub brushes, 84–89

Maintenance chart, 70

Maintenance mode

- definition, 24
- disabling, 26
- resetting timers, 25

Motors, Electric, 82, 117

O

On-off key switch, 12

Operating lights switch, 13

Operation, 5–54

Operation on inclines, 58

Operations

- control panel functions, 15
- stop scrubbing, 50–52

Operator Responsibility, 5

Operator seat, 31

- suspension (option), 31

Options, 58–66

- ES switch, 21
- Positive solution control drain, 30
- Power wand, 62–69
- Power wand switch, 13
- Side brush adjustment knob (Option), 32
- Side brush switch, 23
- Side sweeping brush(es), 92
- Solution tank drain hose, 30
- Vacuum wand, 58–62

P

Parking brake pedal, 10

Pedal, Directional, 10

Pedals

- Brake, 10
- Parking brake, 10

Positive solution control drain, 30

Post-operation checklist, 57

Power kill switch, 13

Power wand, 62–69

Power wand switch, 13

Pre-operation checklist, 36

Propelling circuit, 82

Propelling gearbox, 72

Pushing machine, 109

Pushing or towing the machine, 109

Pushing, towing, and transporting machine, 109

R

Rated incline and descent, 117

Rear squeegee, 99

- Adjusting deflection, 100
- Leveling, 99

Rear squeegee assembly, Removal, 101

Rear squeegee blades, 102

Rear squeegee switch, 22

Rear wheel bearings, 74

Recovery tank, Drain and clean, 36, 57

Recovery tank, 93

- Drain hose, 30
- Draining and cleaning, 51–53
- Positive solution control drain, 30
- Tank full indicator, 21

Recovery tank cover seal, 107

Recovery tank drain hose, 30

Replacing disk brushes, 84

Replacing rear squeegee blades, 102

Rotating rear squeegee blades, 102

S

Safety

- Labels, 4
- Precautions, 3

Screen, FaST System Filter Screen, 95

Scrub brush pressure adjustment, 19

Scrub brushes, 84–89

- Adjusting cylindrical brush pattern, 87–89
- Brush pressure, 19
- Checking cylindrical brush pattern, 87–89
- Cylindrical brushes, 87
- Disk brushes, 84
- Replacing cylindrical brushes, 90
- Replacing disk brushes, 84

Scrub functions, stop scrubbing, 50–52

Scrub head, 83–89

- Adjustments, 83
- Drag link arms, 73
- Floor skirts, 106
- Gas spring, 83

Scrub head adjustments, 83

Scrub head drag link arms, 73

Scrub head floor skirts, 106

Scrub head gas spring, 83

Scrub switch, 19

Scrubbing, 45

- Double, 50

Scrubbing brushes, 43

Scrubbing information, 43

Scrubbing pads, 44

Seals, Tank Cover, 36, 57

Seat, suspension, (option), 31

Self-diagnostics, 80

Service records, 36, 57

Side brush adjustment knob (Option), 32

Side brush switch (option), 23

Side brush(es) (Option), replacement & adjustment, 92

Side squeegee, Adjusting, 102

Side squeegee blades, 104

Side squeegees, 102

Side sweeping brush(es), information, 92

Skirts, Scrub head floor, 106

Skirts and seals, 106–112

- Front cover, 106
- Recovery tank cover seal, 107
- Solution tank cover seal, 107

Solution

- Filling the tanks, 40–42
- Flow lever, 14
- System, 93
- Tank drain hose (option), 30

Solution flow lever, 14

Solution System, 93

Solution system, Solution valve, 93

Solution Tank, 94

Solution tank

- Drain hose (option), 30
- Draining and cleaning, 51–53
- Filling, 40–42
- Positive solution control drain, 30

Solution tank cover seal, 107

Solution tank drain hose (option), 30

Solution valve, 93

Specifications, 116–118

- Braking system, 118
- Chargers, 117
- ec-H₂O System, 118
- ec-H₂O system, 118
- Electric motors, 117
- FaST System, 116
- Hydraulics, 118
- Machine capacities, 116
- Machine dimensions, 116
- Machine performance, 117
- Power type, 117
- Steering, 118
- Tires, 118

Squeegee, 99–102

- Adjustment, 36, 57
- Blades, 102

Squeegee blades, 102

- Rear, 102
- Replacing or rotating rear, 102
- Side, 104

Squeegees, Side, 102

Starting the machine, 39

Static drag chain, 105

Steering, 36, 57

- Specifications, 118

Steering gear chain, 74, 105

Steering wheel, 11
Steering wheel column tilt lever, 14
Stop Scrubbing, 50
Stop the machine, 56
Storage information, 112
Super Scrub switch, 19, 20
Sweeping brushes (Option)
 side brush information, 92
 side brush(es) replacement & adjustment, 92
Sweeping information, 43
Switch, detergent pump (option), 24
Switches
 ec-H20, 15
 Edge scrub, 21
 ES, 21
 FaST, 14
 On-off key, 12
 Operating lights, 13
 Power kill, 13
 Power wand, 13
 Rear squeegee, 22
 Scrub, 19
 Side brush (option), 23
 Super Scrub, 20
Symbol definitions, 7, 8

T

Tanks
 Recovery, 93
 Solution, 94
Tie down locations, 110
Tires, 108–109
 Specifications, 118
Towing machine, 109
Transporting machine, 109
Transporting the machine, 109
Troubleshooting, 68

V

Vacuum wand, 58–62

W

Wheel nuts, Torque, 108

